

Let's Play!



Activities for Families



Ministry of
Education

Acknowledgements

The Ministry of Education wishes to thank the Let's Play Working Group consisting of Child Health BC, YMCA of Greater Vancouver, the BC Association for Child Development & Intervention, and the Vancouver Society of Children's Centres for their input.

Additional contributions were received from Children's Librarian, Vancouver Public Library; D. Hollander, Infant Toddler Educator (YMCA of Greater Vancouver and Vancouver Society of Children's Centres); Fraser Valley Child Development Centre (The CALM Curriculum); L. Androssoff, Métis Parent, Advocate and Early Childhood Specialist; N. Gagné-L'Hirondelle, Provincial Métis Early Years Program Coordinator; and A. Matheson, Vancouver Public Library, néca?mat ct Strathcona Branch.

The Ministry of Education also wishes to thank Surrey Public Libraries for suggesting children's books to support these activities.

Copyright © 2019 Province of BC

Contents

Overview	3
Set 1: Engagement with Others, Materials, and the World	5
Be a Friend	7
Discovery Toy Basket	9
Freeze Dance	11
Let's Go Camping!	13
Mystery Tube	15
Orchestra	17
Personalized Story	19
Reuse, Recycle, and Create	21
Set 2: Communication and Literacies	23
Heart Beat of Mother Earth	25
I am Thankful	27
Mirror Fun	29
Musical Drawing	31
Picture Book Scavenger Hunt	33
Story Stones	35
Talking Stick	37
Triangles, Squares and Circles	39
Set 3: Identities, Social Responsibility, and Diversity	41
The Daily Dilemma	43
Everything Changes	45
Face Collage	47
Family Tree	49
Gardening with Kids	51
People Playdough	53
Restaurant Pretend Play	55
Telling Stories	57
Set 4: Well-Being and Belonging	59
Being Calm	61
Building a Sandcastle or Snowcastle	63
Creating a Bundle of Fun with Watermelon	65
Hummm!	67
Pizza Pizzazz	69
Sleeping Bunny	71
Walking on the Wild Side	73
Yoga Poses	75



Overview

Let's Play! Activities for Families has been developed by the BC Ministry of Education for families and caregivers to support children's early learning experiences through playing and having fun.

Each play activity connects with one of the Living Inquiries described in the BC Early Learning Framework, which are:

- Engagement with Others, Materials and the World
- Communication and Literacies
- Identities, Social Responsibility, and Diversity
- Well-being and Belonging

The activities are intended to create experiences that offer quality engagement within families. This engagement enhances healthy social and emotional development in children. Activities have been carefully chosen to encourage the expression and extension of children's interests and ideas and to present novel and stimulating settings for exploration. The "how" section presents ideas to adapt each activity for children of varying abilities.

Additional tips:

- Encourage your child to lead the play, based on their interests and/or their questions;
- There isn't a right or wrong way to explore the activities;
- When asking your child open-ended questions (examples are provided), give them enough time to process and respond;
- Describe with words what your child is doing as they play; and,
- During moments of challenge or difficulty, support children by helping them to solve problems. For example, "I see this is hard. What could we do differently?" Inviting children to engage in this way will support skill development and increased self confidence.

Enjoy sharing stories with your child! Each activity has one or more suggested books related to the activity themes or topics. Suggested books are currently held by many library locations, and represent a variety of picture books and stories, information books and board books. If you can't find a book, ask your local library staff for help or to recommend another book. You can also check for books and stories in your family's home language.

Let's play and have fun!

Let's Play!

Activities for Families



SET
1

Engagement with
Others, Materials,
and the World



Be a Friend



What

A common perspective is that “it takes a village to raise a child.” This means that an entire community, in different ways, plays a role in raising children, and that different people and viewpoints are needed for healthy child development. Children learn from their parents, caregivers, community, and elders. They will copy and follow adults’ actions, including how to interact with others. Here are some ideas to help your child feel safe and connected with the community and people around them by practicing friendship skills and developing empathy through play.

1 Create the Environment

When a social activity comes up (child care, school, a birthday party, going to a community centre, a playdate, or having a sibling to play with), talk with your child about what’s going to happen, who might be there, and how they might practice being a good friend.

Ask your child what they think it means to be a friend. You may wish to suggest a few things to start the conversation or you may want to read stories about friends. Telling a story using yourself as an example or recalling an example that includes your child might also prompt some ideas. The more your child comes up with ideas on their own, the more they will understand and remember. Here are some examples of what it means to be a good friend:

- Sharing toys/materials
- Taking turns with a toy or activity
- Introducing yourself and smiling
- Responding when someone talks to you
- Being polite, asking to play
- Helping or offering to help
- Sharing with others what you like about them or their efforts

2 Play!

Choose one idea your child has or one idea from the list above to practice during your play time. Play alongside the children and model giving toys or taking turns. Model co-operation and friendliness and say things like, “Here’s a ball for you” or “Your turn on the slide!”

After the activity, tell your child that you noticed what they were doing and positively reinforce that they tried something new. If you noticed other children responding positively, explain to your child what you saw. For example, “You gave a friend a car and she had a big smile! She went to show her mom! I think she was happy.”

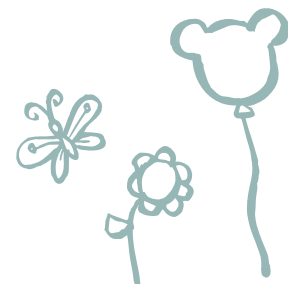

Why

Practicing being a friend will help your child to

- Develop a sense of well-being, belonging, and independence
- Strengthen communication skills
- Develop self-regulation and coping skills
- Support conflict resolution and collaboration skills

How

Have a pretend play date! Collect some stuffed animals, cars, figurines or other toys, and have a birthday party! Try role-play of being at a party.

Children often have a lot of ideas about what it means to be a good friend. Write down their thoughts and encourage them to make a story. You and your child can work together to write the words or draw pictures, or maybe your child would like to do it on their own.

If your child is still learning how to play with or around other children, start with playing next to other children. When your child continues to focus on their own play, and then begins to watch other children, try exchanging toys. In this situation, your child is holding one toy and the other child is holding a different toy. You can encourage the children to trade or model actions and positive responses while saying, "Let's trade toys!"

Go to the playground! These are ideal locations to begin practicing friendship skills because there are often other children nearby, and a lot of space for children to play. Playgrounds offer natural opportunities for introducing oneself, turn-taking, and offering to help.

Read a book with your child about making friends or other ideas that connect with this theme. Suggestions are:

- *Have You Filled a Bucket Today?* by Carol McCloud
- *The Rabbit Listened*, by Cori Doerrfeld

Check out *erase = expect respect & a safe education* for tips and tools about safe and caring school communities and much more: <https://www2.gov.bc.ca/gov/content/erase>

Where

Children can practice friendship skills in any environment.

When

You can practice when children are in a variety of emotional states (excited, calm, tired). Keep in mind that skill levels vary based on how we are feeling.

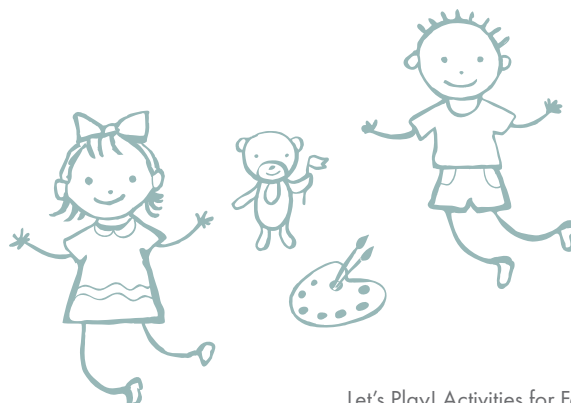

Discovery Toy Basket

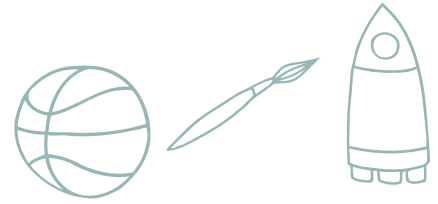

What

This experience is inspired by the idea of “Heuristic Play,” a term coined by Child Psychologist, Elinor Goldschmeid. It simply means to discover the properties of objects. This activity is also called “Heuristic Toy Basket.”

1 Create the Environment

- Place a variety of found objects such as keys, kitchen utensils or other household items into a basket, and present it to the child without directing their play.
- If you happen to be away from home, try a themed collection of items from your surroundings (for example, natural materials found at a beach or park). Any container (a bowl or a bag) that can hold your collected items can be used instead of a basket.

2 Play!

This child-led play allows endless opportunities for exploration, creativity, and invention! In addition to developing creativity, children learn the fundamentals of science by using their senses to explore what they find in the basket. By asking open-ended questions you are also able to support the development of children’s communication and literacy skills.

Why

Through this experience, children will learn to

- Explore the world using their bodies and all of their senses
- Develop their abstract and critical thinking skills, as well as their creativity and invention skills
- Build independence and confidence as new objects are explored
- Enhance fine motor abilities through manipulating, opening, closing, and pulling items apart

How

Some suggested items are hair rollers, cups, wooden spoons, a metal whisk, shaker, an empty spool, an old CD, old keys, bubble wrap, or small carpet samples and fabric scraps. Include natural items and materials such as driftwood, shells, rocks, leaves, and pinecones.

Add different items such as stacking objects (Russian dolls or measuring cups). You can also try larger marbles, holiday ornaments, sea sponges, a jar of buttons, rubber tubing, acorns, plastic flowers or plants, a wooden brush, an egg carton, or a clothespin.

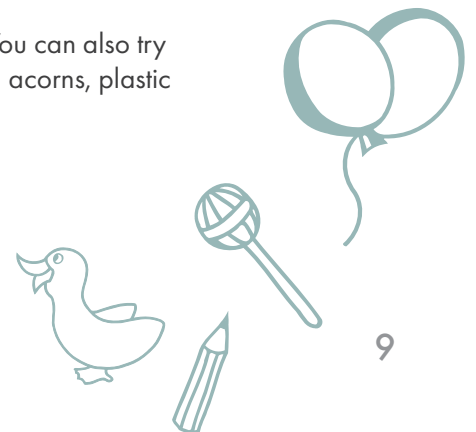

Ask open-ended questions such as

- “Can you tell me what you have found?”
- “What do you see/feel/hear?”
- “What do you think this is used for?” There are no right or wrong answers. You are asking what is being sensed and how the child is interpreting the object
- “Do you like how it feels (and why)?” or “How does it make you feel?”

Place smaller objects into a fabric bag or sock. With no direction, a child will naturally feel around the sock and reach inside to explore the hidden items. Ask open-ended questions — a guessing game of what is inside may naturally emerge. Remember to focus on the senses to help children feel and guess what is hidden.

Read a book with your child about found objects or other ideas that connect with the activity. Here is a suggestion:

- *Ashley Bryan’s Puppets: Making Something from Everything* by Ashley Bryan

Where

This experience can be completed anywhere, preferably in an area with ample room for a child to spread out items and explore them individually.

When

This activity can occur at any time of the day and is best explored individually or in small groups.

Reference

Ranson, Anna (2010, October 28), *Heuristic Play-Treasure Basket*. Retrieved from <https://theimaginationtree.com/heuristic-play-treasure-baskets/>

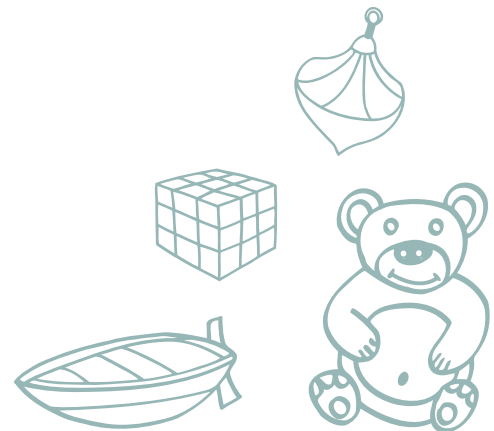

Freeze Dance



What

Children are interested in music, rhythm, and dancing. Try this activity that explores music literacy skills. This experience encourages children to explore music and dance from diverse cultures. Through play, children can practice various ways of moving as well as controlling their impulses.

Many children know and love the game "Freeze Dance." Children dance or move to music, but when the music is turned off, children must freeze their body in their dance/movement position. This version of a "freeze" game introduces children to songs and rhythms of varied cultures. You will need a source of cultural music for this activity such as YouTube, a music streaming application, or a radio station that plays world music.

1 Create the Environment

- Invite your child to play a dancing game.
- Find or create a space together where you can use your whole bodies to move while listening to music.
- Explain that the game is to dance and freeze to music.
- Practice a few times together using the cues "Dance!" and "Freeze!" either with or without music.

2 Listen and Freeze!

- Listen to songs from your own culture or from around the world and dance to them.
- While you are dancing, turn off the music and say, "Freeze!"
- Observe when your child is ready for a different song, or when to change or finish the game. Talk about your observations by saying, "It looks like you're ready for a new song. Should we try the next one?"

Why

Through this experience, children will

- Learn multicultural songs, including songs from your own culture and traditions
- Practice self-regulation by taking control of their bodies to either start or stop dancing
- Increase communication and music literacy skills

How

Ask your child which song they would like to listen and dance to. Dance along to the song with your child.

If your child is not yet freezing on command, help them to freeze by scooping them up, or holding their hands and making silly faces. Say, "Freeze!" each time to help them make the connection.

Children may be able to turn off the music when they want everyone to "freeze." Or, follow their lead when they freeze on their own.



Find different types of music from around the world that can be played during different parts of the day. For example, in the morning or afternoon, play music that is energizing. In the evening, choose music that is more calming and soothing.

To support their conversation skills, ask your child questions like, “How do you feel when the song is played?” or “What is your favourite part of the song?” In exchange, share how you feel and share your favourite part, too.

Try asking where your child would like to dance. This experience can easily occur inside or outdoors. Ask your child “Do you like dancing outside? Or is it more fun to dance inside? What do you like better?” Let your child choose where they would like to play.

Read a book with your child about dancing or other ideas that connect with this theme.

Suggestions are:

- *The Jingle Dancer*, by Cynthia Leicht Smith
- *Dance Baby Dance*, by Andrea Spalding

Where

This activity can take place where there is enough space for children to move around and where music is accessible.

When

This activity can take place any time throughout the day.



Let's Go Camping!

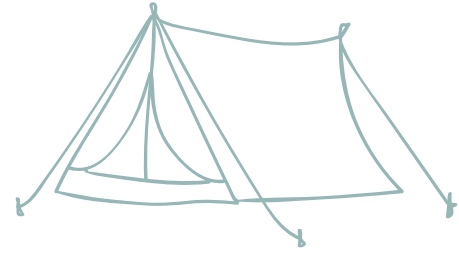

What

Real camping or pretend camping is a great way to get your child excited for the start of springtime weather, and to get outside more and enjoy nature! Here are some steps to create a fun camping experience with your child:

1 Create the Environment

- Set up play tents (or small real ones).
- Provide sleeping bags and even create a pretend fire made of wooden blocks in brown, red, orange, and yellow (or create from old paper towel rolls and tissue paper).
- Make a forest mural painted with trees, a starry night sky, and some woodland animals with your child.
- Tell your child, "Let's think of one kind thing we could do for each other while we're camping."

2 Camping Activities

Ask your child what sort of activities they would like to do while camping. Some ideas:

Go fishing!

- Fill a blow-up paddling pool, or other shallow tub with cardboard fish cut-outs with paper clips for mouths or pipe cleaner fish.
- Make fishing poles out of sticks, string, and magnets tied on the end, or use pipe cleaners formed into hook shapes.
- Catch your fish! As you catch fish, talk with your child about how fish live in our rivers, lakes, and ocean, so fish is common in the diet of people in BC.

Storytime

- Sing camp songs and tell ghost stories (age-appropriate, of course), or tell stories from your cultural background that you learned or heard as a child from your family or community.
- Read a book from your local library or a story from your bookshelf that would be fun to read around the "campfire."

Explore nature outside

- A big part of camping is to enjoy nature. Even if you are pretend camping, go outside in your backyard or to a nearby park with your child and look at the trees, flowers, leaves, and animals that are around you. Feel and smell the different types of plants you know are safe. Hear the birds chirping. Ask your child questions about what they hear, smell, and feel.

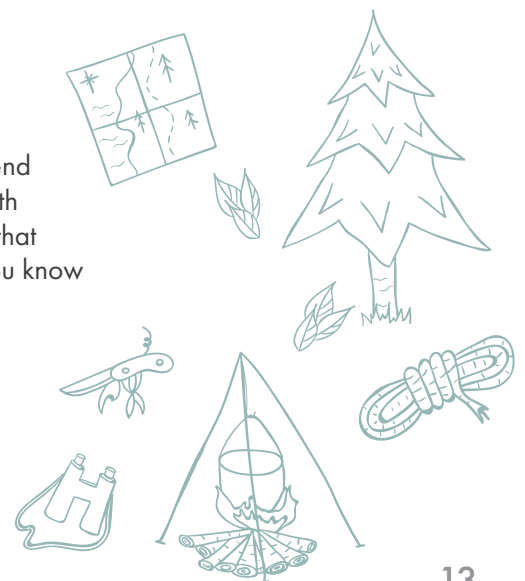

3 Try creating “Camping Food”

Ask your child, “What types of foods would you like to eat while camping?”

Try exploring fun and nutritious camping foods such as



- **Bannock or Fry Bread:** Talk to your child about how bannock can be made on sticks over the fire. Serve with plain yogurt and berries, or melt cheese on top or in the middle. A recipe can be found here: <https://www.appetitetoplay.com/healthy-eating/recipes/bannock>
- **Potato Boats:** Wrap small potatoes in aluminum foil and bake in oven at 400 degrees for around 30 minutes or until easily pierced with a fork. Allow to cool slightly, then give one to your child. Try offering toppings such as cheese, Greek yogurt, green onions, steamed/diced broccoli, cooked beans, or chicken.
- **Banana Splits:** Have your child help prepare the bananas by laying a whole or half banana on a sheet of greased aluminum foil or parchment paper. Allow your child to practice cutting by using a plastic knife to cut the banana in half lengthwise. Try offering them toppings such as shredded coconut, semi-sweet chocolate chips, granola, berries, and nuts, or seed butter (depending on allergies). Bake in a 200 degree oven for 15-20 minutes until bananas are no longer firm when squeezed with tongs. Let cool slightly before serving to your child in the foil for true camp-style eating!

Why

Through this experience, children will learn to

- Explore the world around them using their bodies and their senses
- Build, create, and design using different materials
- Be creative and expressive in a variety of ways (for example, singing, storytelling)
- Develop a sense of wonder for natural environments

How

Together with your child, try the activities based on their interests.

- Create a space for your child to explore the different activities independently, and try watching from the sidelines. Observe their interests, and ask questions that encourage exploration.
- Encourage your child to think of new games and ideas that use the camping theme.
- Read a story with your child about camping or other ideas that connect with the activity. Here is a suggestion:
 - » *Scaredy Squirrel Goes Camping* by Melanie Watt
- Check out BC parks: <http://www.env.gov.bc.ca/bcparks/reserve/>

Where

This activity can occur either indoors or outdoors. Playing pretend camping in the backyard is always fun and exciting.

When

Try these activities in the morning or the afternoon. Storytime can happen at any time of the day.

Reference

Child Health BC. (2017). Appetite to Play. Retrieved from <https://www.appetitetoplay.com/healthy-eating/tips-ideas/lets-go-camping>

Mystery Tube

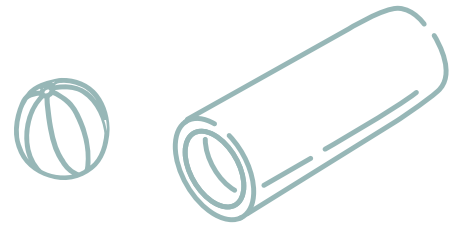

What

Try this experience if your child is showing interest in manipulating objects, hiding smaller objects in larger objects, or is curious about the different components of toys or objects.

This experience involves experimenting and predicting what might happen when your child rolls balls of different sizes through a tube (poster tube, or piping for construction often works well).

1 Create the Environment

- You can find poster tubes that people have received in the mail. Often they will give them to you for free. You can use tennis balls or other balls you may already have.

2 Play!

Start with one ball that fits through the tube. Put it in on one side and lift that side so the ball comes out the other way. Talk to your child about what you're doing. "Let's put the ball in here. Is it going to fit? Yes! What will happen if I lift the tube? Wow! It came out the other side!"

Look through the tube at the child on the other end. Let the child try it and comment on what is happening. Try making different faces for your child to copy or label.

Once the child has had an opportunity to explore the tube and ball, you can add other balls of different sizes. Some will fit, some won't. Try reflective talking with your child by speaking about what your child is doing. "You put the ball in the tube!"

Have fun experimenting together and talk about what is happening to enrich the child's understanding and vocabulary. Use words like "big, bigger, biggest, small, smaller, smallest, fits, doesn't fit." Ask the child what they think will happen (making predictions).

Why

Through this experience, children learn to

- Explore two objects and how they interact with each other in a new way
- Predict what might happen (the foundation of many scientific experiments)
- Explore new vocabulary as well as numerical concepts, such as counting the amount of balls you are sending through the tube, and talking about the colours and sizes of the balls

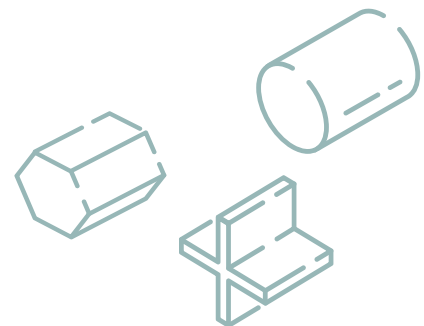

How

You can start to explore the tube and the ball separately. Play peekaboo through the tube, and roll the ball back and forth. Once the child is familiar with both objects, you can combine them.

Roll the ball through the tube, and then, give your child some time to explore and try it. Comment on what's happening. You can ask your child to predict what is going to happen like, "What happens when you put the ball in and you don't lift the tube?" You can also introduce different sized balls. Some will fit, and some won't. Try asking questions like, "What happens when you put in a smaller ball or a larger ball?" Your child can try to predict what will happen.

Try asking your child, "What else can you do with the materials?" They may want to build a structure that includes ramps or different types of tracks. Encourage them to experiment and explore with different types of materials, balls, and objects, and predict what is going to happen.

Read a story with your child about exploring or other ideas that connect with the activity. Here is a suggestion:

- *Not a Stick* by Antoinette Portis

Where

This activity can be played indoors or outdoors.

When

As with all activities, it's best to play when your child isn't sleepy or hungry but feels alert and ready to explore.

Reference

Community Action Program for Children (CAPC).

Retrieved from <https://www.canada.ca/en/public-health/services/health-promotion/childhood-adolescence/programs-initiatives/community-action-program-children-capc.html>

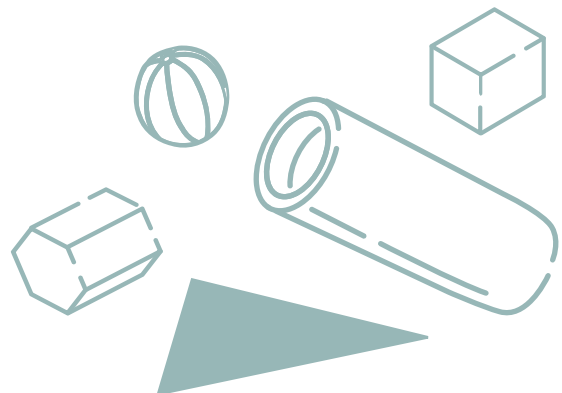

Orchestra



What

Even before birth, babies begin to gain awareness of their world through sound. Whether it is the sound of their mother’s heartbeat, voices of their parents, or music, children develop the foundation for language and communication through these sounds.

1 Create the Environment

- Introduce instruments (or items that make sounds) to your child. These “instruments” could be pots, plastic cups, items that jingle, a whistle, or anything that makes an interesting sound. Allow ample time for your child to explore these items freely. This will help them focus on guidance that will be provided later in the activity.
- Help your child to experiment with different tones, rhythms, and sounds by using a variety of instruments.
- While your child explores the instruments, explore along with them. Make comments and tell stories about music you both enjoy or musical experiences you’ve shared. This helps children make connections across events and environments.
- Consider using noise-cancelling headphones for children with an auditory sensitivity, so they can explore without being overwhelmed.

2 Play in an Orchestra!

- Explain the role of a conductor in an orchestra. Talk about different types of instruments and model how a conductor guides an orchestra by conducting. Express the importance of the conductor’s role as a leader of the group and the use of a baton in conducting.
- Find something to use as a conductor’s baton, such as a wand or wooden spoon. Wave or move the baton and together you can interpret what each movement might mean. Try these movements and interpretations or make up your own: wave the baton gently from side to side (free play), bring it up high (loud), down low (soft/quiet), and make a tapping motion in the air (play to the beat). Try holding up your hand with an open palm and close it into a fist, explaining how this means that you would like music to stop. Together, you and your child can decide on what other movements mean. Practice these movements a few times.
- Move around in a space with the instruments, like a marching band, which encourages moving or marching to the music. This supports large motor skill development.



Why

Through this experience, children will

- Develop a sense of well-being, belonging, and self-confidence,
- Practise large and small motor skills
- Strengthen literacy and communication skills
- Develop artistic expression and musical interest
- Engage in turn taking, co-operation, and listening

How

In a group, everyone can take turns being the conductor and leading the speed and rhythms of the orchestra. Children sometimes need support with taking turns, so a visual aid, such as a sand timer or egg timer can help to understand how long turns will take.

Take the opportunity to introduce new vocabulary such as rhythm, tempo, orchestra, conductor, baton, volume, and beat. Invite children to clap after each conductor, which will contribute to children's positive self-esteem and confidence.

Have a performance! Practice a few times together by using a variety of instruments. Consider extending this activity by using costumes, inviting guests, and setting up a stage and a place for an audience.

Consider introducing more complex vocabulary related to tempo (the speed at which a piece of music is played): *presto* (very fast), *allegro* (fast/ lively), *moderato* (moderate), *andante* (moderately slow or slow walking), and *adagio* (very slow).

Choose songs or music together and practice conducting and playing along freely or to the beat.

Read a book with your child about playing in an orchestra or other ideas that connect with this theme. Here are suggestions:

- *The Orchestra Pit*, by Johanna White
- *Play This Book*, by Jessica Young

Check out Performing Arts BC for regional festivals of the arts: <http://www.bcprovincials.com/>

Where

This activity can occur indoors or outdoors.

When

This activity can be explored when children, family, or caregivers are ready for sounds and noise.



Personalized Story



What

Children may experience some difficulty in adjusting to new routines or experiences. Creating a Personalized Story to support transitions, while also supporting early literacy can be helpful. In this activity, you and your child will talk and write about something new or challenging.

1 Create the Environment

Talk with your child about a challenging experience or routine. Explain that you are going to write a story together about how it looks, feels, and its participants. Your child can help you choose a theme. Some common themes are

- Getting ready in the morning for school or child care
- Getting ready for bed
- Trying new foods
- Going to the doctor
- Going to the dentist

2 Gather pictures

If you have access to a computer and printer there are many free clip art images available online, or you can draw and colour your own.

3 Write some words or sentences to accompany the pictures

The content should be as specific as possible using names, a range of emotions, and situations that are familiar to your child. The phrases should be simple, clear and reflect your child's perspective. The story should go through the whole routine, from start to finish, and show a success. Examples include

- At school, I like...
- I think it's scary when...
- I can ask for help if...
- My caregiver will be so proud when I...

4 Assemble your Personalized Story

Staple the pictures together to create a booklet or use a large piece of paper or poster board to display pictures in a sequence. If the routine changes sometimes, you may want to keep the pictures loose and separate, so they can be mixed and matched for different sequencing of events.

5 Read or tell the Personalized Story

Use the pictures to read or tell the story to each other.

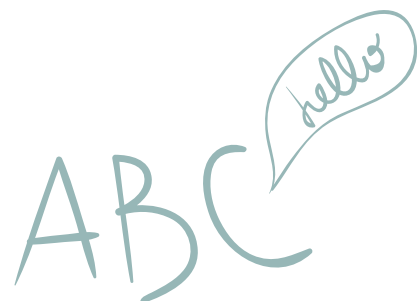

Why

This activity aims to

- Break down the sequence of a child’s routine and prompt conversation about possible challenges. This supports emotional expression and helps to develop language about feelings.
- Help build vocabulary during the creation of the Personalized Story and its ongoing use.
- Support children’s narrative skills. Personalized Stories allow for storytelling—an effective way to help support early literacy skills.
- Develop creativity through imagining a topic for the story and drawing pictures to explore the topic.

Once completed, children will gain confidence and fulfillment in creating something new.

How

Create a Personalized Story together. Explore different pictures and work together to choose, colour, and arrange pictures.

When reading the story, talk about different aspects of it and ask open-ended questions. For example, if the story was about “Getting ready for Bed,” you might ask, “What’s your favourite part of getting ready for bed?” “What’s the hardest part?”

Stories can be explored and reviewed by flipping through or pointing to the pictures. Ask for descriptive information as you share with each other.

Some other ways of interacting could be to

- Talk about what is in the pictures
- Practice counting pages or objects
- Create rhymes based on the photos
- Make up a song together inspired by the pictures, topics, or words

Read a book with your child about challenging routines or other ideas that connect with this theme. Suggestions are:

- *The Kissing Hand*, by Audrey Penn
- *Froggy Gets Dressed*, by Jonathan London

Where

Personalized Stories can be created at home, in a library, classroom, or community centre.

When

A Personalized Story can be read anytime. They are portable and can be used as needed. Personalized Stories can be especially useful right before a routine occurs, to help prepare your child for the routine or afterward, to reflect on their experiences.



Reference

Hotson, D. Adapted from Vancouver Public Library Workshop-
Parent’s Time Out: Familiar Routines and New Experiences.

Retrieved from <https://www.autism.org.uk/about/strategies/social-stories-comic-strips.aspx>



Reuse, Recycle, and Create

What

One way to support creativity and exploration with children is to keep things simple!

1 Create the Environment

- On a table or flat surface, place a variety of recyclable items such as plastic bottles, paper, and cardboard tubes or boxes.
- Ask your child to help you collect materials like tape, glue sticks, string, and scissors.

2 Explore

- Encourage your child to get started!
- Ask, "I wonder what we could do with all of this?"

Why

This activity encourages children to plan and construct new creations and problem solve while making or creating a design or sculpture.

Through this experience, children will learn

- How their actions may affect nature and the planet
- Abstract and critical thinking skills, creativity, and innovation
- Language development and communication

Once completed, children will gain confidence and fulfillment in creating something new.

How

Provide an opportunity for your child to explore the items with their senses. Children will manipulate the different items and begin to explore, evaluate and inquire. Some suggested items could be egg cartons, empty milk bottles, cardboard boxes, tins (omit cans as they can be sharp and unsafe), plastic containers, old CDs, or gift wrapping papers or bows.

Add miscellaneous pieces of toys, plastic caps, plastic straws, plastic or foam mesh, or pieces of Styrofoam. Encourage the child to explain what they are making and how they are making it. If your child asks for help, try to ask open-ended questions to encourage them to find solutions on their own. For example, "I hear you saying you are having trouble keeping the tower up. What other items could you use to hold it up?"



Depending on the interest of the child, you might place images of animals, structures, or objects that they could try to replicate using recycled items. Ask questions about recycling — like what items can be recycled, how items are recycled, and what recyclable items can be reused for. This will enhance a child’s knowledge of social responsibility with respect to their own or other communities and the world.

Read a book with your child about recycling or other ideas that connect with the activity. Here is a suggestion:

- *The Most Magnificent Thing* by Ashley Spires

Where

This experience can be completed on a flat surface: ideally at a table, indoors or outdoors.

When

This activity can occur at any time of the day, and best explored individually or in small groups.



Let's Play!

Activities for Families



SET
2

Communication and Literacies

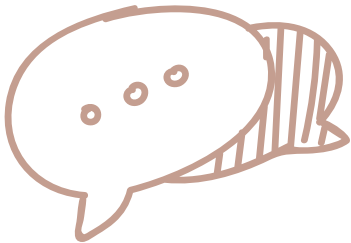

Heart Beat of Mother Earth



What

This activity engages parents and children in a musical and cultural experience. Children are interested in rhythm, dancing, or moving to music. This activity supports their interest in music through drumming. They do not care if you think you are a terrible singer or musician, they just care that you sing and play along with them.

1 Create the Environment

- Introduce a range of objects of various size and materials that will make a collection of sounds when they are banged on or hit. Together, look for unique objects around your home for drumming. During the hunt, talk about which objects might be good for drumming and why.
- Be curious about objects you collect. Together, wonder aloud about the sounds they will make and what objects might sound like when used at the same time.

2 Drumming

- Encourage your child to drum with objects found around your home such as pots and pans, bowls or containers, and wooden or metal spoons. Let your child explore the objects freely, and remember to have fun!
- Talk about the beat of your heart with your child. Notice how your heart beats slow or fast when you are doing different activities. Some Indigenous people refer to the drum as the heartbeat of Mother Earth.
- Listen to music with different drumbeats. Try different drumbeat speeds and sounds —slow, fast, hard, and soft.

3 Singing

- Try this fun song that one Métis mother/educator uses with children. Pick any animal you like and have fun with the sounds they make.

Song:

Mother Earth Has a Forest – to the tune of “Old MacDonald Had a Farm.”

Mother Earth Has a forest – Hey yah hey yah hey!

And in that forest, she has a Bear – Hey yah hey yah hey!

With a Grrr...grrr...here, and a grrr...grrr...there.

Here a grr...there a grrr...everywhere a grrr...grrr...

Mother Earth Has a Forest – Hey yah hey yah hey!

Repeat with other forest animals and sounds such as: Wolf (Awhoohoo), Snake (Ssssssss), Frog (Ribbet), Robin (Tweet).



Why

Through this experience, children will

- Develop communication and literacy skills
- Develop motor skills, strength and control and hand-eye coordination
- Express emotions, self-regulate, focus, and attend to one activity
- Communicate thoughts and experiences creatively using many different forms of expression
- Develop diverse language abilities, rhythm, and the capacity to communicate with others in many ways
- Engage in sound and word play
- Experience the stories and symbols of their own and other cultures

How

Find a variety of materials inside and outside for your child to drum, bang, and make music. Drum along with your child. Copy your child and encourage your child to copy you. Explore different spaces for drumming. How do your instruments sound inside and outside? How do they sound in the bathroom as compared to a larger space?

Choose a song to sing or nursery rhyme to sing together while you drum, or take turns drumming and singing.

This is a fun activity and it can happen as soon as your child is sitting up or grasping things and moving them intentionally. All children love to bang objects!

Read a book with your child about drumming or other ideas that connect with this theme.

Here are suggestions:

- *Drum City*, by Thea Gudione
- *The Drum Calls Softly*, by Dave Bouchard

Where

This activity can occur both indoors and outdoors at any time during the day.

When

Drumming can be introduced to children at a very early age. They may sit on their own or on your lap and hold an object to bang it. Drumming or singing can also be a calming activity and may be a way to help your child change focus after an exciting activity or a disappointment.

Reference

L. Androssoff, Métis Parent, Advocate and Early Childhood Specialist (song).



I am Thankful



What

This experience provides an opportunity for children to share their gratitude with others.

1 Create the Environment

Before your child goes to sleep, tell them about someone or something you love, or something wonderful that happened to you that day.

2 Sharing Experiences

Ask your child to think about someone or something they love, or something wonderful that happened to them that day. Maybe they are thankful for having fun, spending time with a relative, sharing a family meal, or making a new friend.

Guide your child to take three soft, slow breaths, and feel thankful. This encourages your child to be mindful and reflect on their experiences.

Why

Through this experience, children will learn to

- Reflect on themselves and how they feel
- Communicate thoughts and experiences creatively using different forms of expression
- Be curious about vocabulary, concepts, and written language
- Express their points of view and reflect on others' views

How

Try the activity as described. You can remind your child about the day's activities or share what you noticed.

Help your child write down what they are thankful for. Ask your child to draw a picture that represents the words you have written together.

Wake up in the morning and try revisiting what you were thankful for with your child. Use this activity as a reminder of the good things in your life.

Read a story with your child about gratitude or other ideas that connect with the activity. Here is a suggestion:

- *Orca Chief* by Roy Henry Vickers & Robert Budd



Where

This activity can occur anywhere.

When

Try this activity before your child goes to sleep.

Reference

Braun, M., & Stewart, W. (2017). *Mindful Kids: 50 Mindfulness Activities for Kindness, Focus and Calm*. [Activity Deck]. Cambridge, MA: Barefoot Books



Mirror Fun



What

Mirrors are an entertaining, engaging way to help your child explore faces, expressions, self-awareness, and the movements and expressions of others. Children of all ages love to explore their reflections and how they can change.

1 Create the Environment

- Use any mirror you have access to. Hold your baby in front of a hallway mirror, or lay your child on their tummy, down on the floor in front of a full-length mirror or use a hand-held mirror while cuddling your child on your lap. If you are using a large mirror, ensure that it is stable or securely mounted.

2 Mirror Fun!

- Sit in front of a mirror with your child. Together with your child, talk about what you see. Pay attention to labeling emotions and facial expressions.
- This activity is all about conversation and naming feelings in a positive, relaxed way. Be flexible and have fun! Let your child take the lead.

Why

Exploring emotions and facial expressions in this way supports

- Recognizing emotions in themselves and others
- Building a rich emotional vocabulary, which aids in communication and self-awareness
- Identifying and anticipating what influences emotions in themselves and others

How

Place your child in front of the mirror and draw their attention to their reflection. You can do this by tapping the glass or moving the mirror (if it is a hand-held mirror). Look in the mirror together and talk about what you see, using their name. Some examples

- “Look at the baby in the mirror! That’s you, Enrique!”
- While pointing at various body parts, “There are your (blue/brown) eyes. I see your nose. I love your pink cheeks. There is your mouth smiling at me. What a happy baby!”
- “You look so serious. Are you wondering who that is in the mirror? That is, you, Lucy!”
- Wave baby’s hand, “I am waving your hand. Hello!”

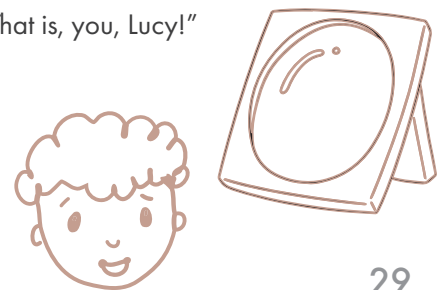

Pay attention to where your child is looking. If something has caught their attention, talk about it. If your child is learning to talk, guess what they are looking at and repeat the single word. If your child babbles, give them time to talk and then respond so that you are having a give-and-take conversation (even if you can't understand what they are saying).

Try modeling different facial expressions and ask your child to play along by copying you. Talk about what you are doing and label different faces for different emotions. Encourage children to copy you or come up with their own silly faces! You can turn this into a guessing game, with each of you taking a turn. Try introducing more complicated feeling words as your child matures. Some examples

- "Look at my big smile! How am I feeling right now?"
- What do you look like when you are grumpy or unhappy? Can you make a grumpy face? Look at how my eyebrows go down when I am feeling unhappy. Can you do that?"
- "Do you remember this morning, when I came into your room, and you had climbed out of your crib all by yourself? I was so surprised! I looked like this. Was there a time that you felt surprised?"

Make sure to give your child lots of time to answer questions. Young children often need several seconds (or more) to listen to a question and then form a response. As always, let your child take the lead.

Try telling a short story and have your child act out feelings in front of the mirror. You can also copy emotions if that is more fun. Give your child plenty of time to decide what emotion the character feels and to make the same facial expression. Provide supportive dialogue or hints if they are struggling. Encourage your child to be goofy or dramatic with you! An example

- "Once upon a time, there was a girl named Little Red Riding Hood. One day, her father asked her to bring a basket of treats to her grandmother. Little Red Riding Hood was in the middle of a game and really didn't want to go. Can you show me how Little Red Riding Hood felt? How did she feel? She did NOT want to leave her game. What face do you make when I ask you to do a chore when you are playing?"

Try using props (i.e. sunglasses, scarves, hats, necklaces) to change your appearances. Take turns helping each other put on and take off different items.

Read a book with your child about playing with mirrors or other ideas that connect with this theme. Here are suggestions:

- *Do Your Ears Hang Low?* by Jenny Cooper
- *I See Myself*, by Vicki Cobb

Where

This activity can occur anywhere there is a mirror to use.

When

This game can take place any time of day, but is most successful when your child is alert, focused, and in the mood to play and interact.

Reference

Herr, J., & Swim, T. (2003). *Rattle Time, Face to Face, and Many Other Activities for Infants: Birth to 6 Months*. Clifton Park, NY: Thomson/Delmar Learning.



Musical Drawing



What

This experience explores the senses of sight and sound together and can be very fun for your child if they show interest in music and rhythm.

1 Create the Environment

- Choose any type of music that your child and you listen to, or perhaps important in your community, such as different types of drumming, dance, or other types of instrumental music.
- Tape a large piece of easel paper to the floor, or use regular size paper. Bring out some crayons, markers, chalk, or finger paint.

2 Musical Drawing

Play the music and encourage your child to draw or paint on the paper, using the drawing tools, according to what they hear in the music.

Why

Through this experience, children will learn

- Explore the world using their bodies and senses
- Build, create, and design using different materials and techniques
- Actively explore, think, and reason
- Be creative and expressive in a variety of ways
- Express a zest for living and learning

How

Encourage your child to draw or paint based on the music that is being played. If you are using paint, try to add other elements such as soap or sparkles, so they can see the different textures of the paint they are using.

You can ask how the music made them feel. Did the music make them happy? Did the music make them sad? Did the music make them calm? Are those feelings anywhere in the picture?



When the music is complete, and your child has finished drawing, ask your child questions about their drawing:

- What did you make?
- What colours did you use?
- What types of drawing tools did you use?
- What was your favourite part of the music? Where is that in the drawing?

Observe your child's drawing and get curious. For example, you might notice that there is one area that is sparse, or one area that has a lot of drawing on it. Ask your child why they drew it like that.

Read a story with your child about music, drawing or other ideas that connect with the activity.

Here is a suggestion:

- *Sam & Eva* by Debbie Ridpath Ohi

Consider visiting an art gallery or a nearby museum for inspiration:

<https://www.hellobc.com/things-to-do/museums-heritage-sites>

Where

This activity may get messy if using paint. Try this experience either inside or outside.

When

This activity can occur during any time of the day.

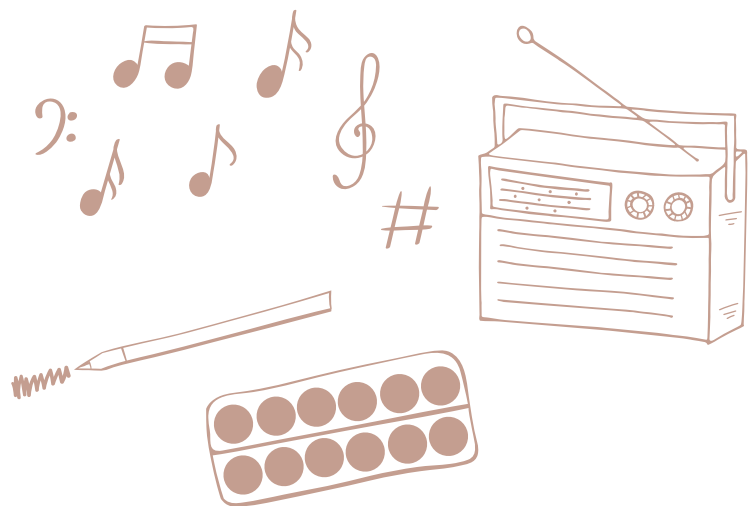

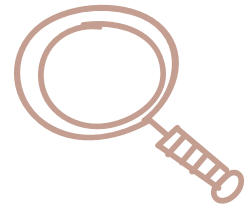

Picture Book Scavenger Hunt

What

This is an interactive way of exploring reading and literacy while incorporating physical activity. Use picture books as the basis for a scavenger hunt.

1 Create the Environment

- Pick a favorite picture book (preferably one with human characters and familiar locations). After you read it through once or twice, ask your child if they would like to try and find things they see in the book!

2 Play Scavenger Hunt!

- With your child, identify the things that you see in the book and that you will hunt for (e.g., dog, table, car, tree). Then take your book outside or to a new room and try to find things from the real world that match what is in the book.

Why

Through this experience, children will

- Make connections between reading materials and the real world
- Develop receptive (heard/read) and expressive (spoken/signed) language
- Identify printed language in different settings
- Make connections between ideas and objects
- Develop an awareness of printed language
- Enhance communication and literacy skills

How

You might start inside your house with toys or items that are familiar to your child. Try choosing a board book with one object on each page, then go find the object together. Hold the object close to the picture and label it twice. For example, if you're reading a book about children's toys, and you see a teddy bear, go together to find one and say "bear" while pointing at the picture, and then "bear" while pointing at the object.

Try moving beyond looking for simple objects by looking for **types** or **categories** of things. For example, if you see an apple in the book, ask your child to find another fruit, or another healthy food at home or the grocery store. You could also look for colours or shapes based on the images you see. If you see squares in the book, ask your child if they can find a square near you. Try looking for numbers or letters as well.

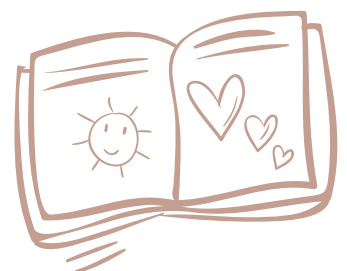

You could try collecting objects found in books ahead of time and put them inside a bag. Have your child close their eyes, reach in and pull one out. Then try to find the object inside the book!

For children who are beginning to read, you could ask them to look for objects in the book out in the real world. You might try looking for **concepts** or **qualities**. If something in the book is up high, try to find something else that is up high. If a character is wet, try to find something else that is wet. To make this more challenging, you could try finding opposites.

If the activity is too challenging, or your child gets distracted, try again with a different book. Try gathering objects ahead of time and hide the objects in your home. Make it a race to find them!

You may find that this activity is rewarding enough in itself, or you may choose to use a reward for a certain number of found items.

Read a book with your child about searching for or matching things, or other ideas that connect with this theme. Here are suggestions:

- *Cycle City*, by Alison Farrell
- *Where's the Pair?* by Britta Teckuntrup

Check out BC public libraries for books and much more!

<https://www2.gov.bc.ca/gov/content/sports-culture/arts-culture/public-libraries>

Where

This activity can occur anywhere you are. You can do this activity at home, out and about while you go about your day, or during a walk and exploring. By taking the activity outside and searching for items, not only will you be supporting your child's literacy, you will be promoting physical activity at the same time.

When

This activity can occur any time. It is best for a single child, or a small group of children, though it could also take place within a larger group.

Reference

Lawhon, T., Cobb, J.B. (2002). Routines that Build Emergent Literacy Skills in Infants, Toddlers, and Preschoolers *Childhood Education Journal*, 30(2), 113-118.



Story Stones



What

This activity originates from a tradition of Aboriginal peoples of Australia. Story Stones are painted stones kept in a small pouch and used as a tool to tell stories.

Simplicity is key for this activity. Paint or draw various simple images that support the child's different interests on small rocks. Once dried, place them in a pouch.

Invite the child to explore the stones and create their own stories using the rocks.

Why

Through this experience, children will learn to

- Communicate thoughts and creatively use many different forms of expression
- Experience the stories and symbols of their own and other cultures
- Express their points of view
- Understand abstract and critical thinking, creativity, and invention
- Be independent and confident as they take initiative to create storylines
- Enhance their communication and literacy skills

How

Paint simple images on the stones: house, dog, cat, tree, car, mountains, waves, and individual people (possibly even small caricatures of family members). For some children, this will act as more of an explorative or sight-word activity. Encourage your child to repeat the name of the image several times with you.

Allow the child to explore the stones. Some children will automatically create a storyline whereas others may need some encouragement. You can support children's development by having them explain the symbolism of the stones and ask them who the characters are or what the images represent. Ask probing questions such as "Where do they live?" or "What are they doing?" to help them develop a storyline.

Your child can paint their own rocks. This will allow them to take full ownership over the activity and highlight and encourage their ideas and creative thinking. Also, try encouraging your child to develop a storyline.

Read a story with your child about creativity or other ideas that connect with the activity. Here is a suggestion:

- *Zen Shorts* by Jon J Muth

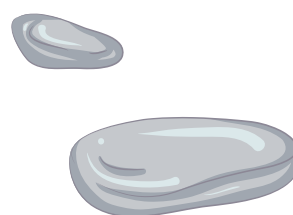

Where

This experience can be completed anywhere, preferably in an area with ample room for the child to spread out the stones to create their story.

When

This activity can occur at any time of the day, and may be explored individually or in small groups.

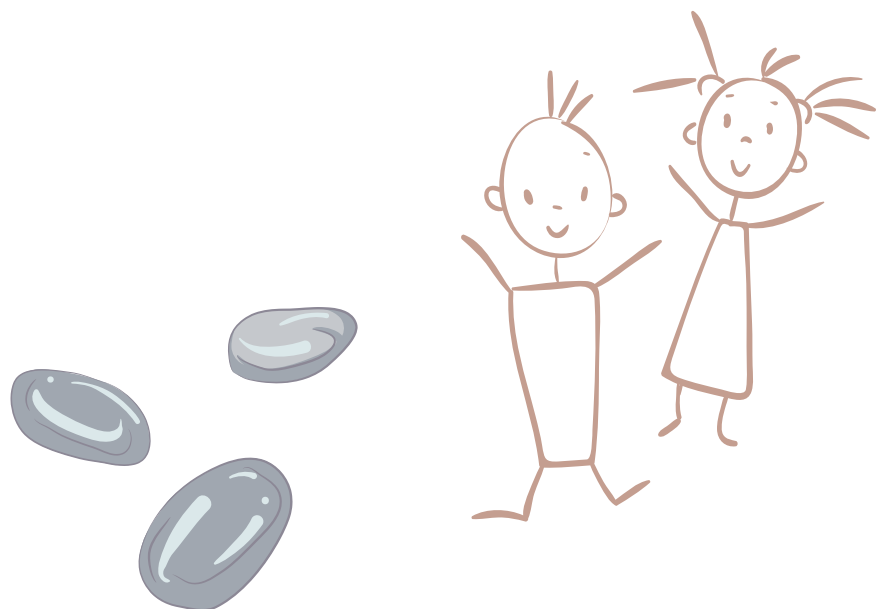

Talking Stick



What

This experience is modelled after the use of Talking Sticks by many Indigenous peoples. It is a powerful tool for respectful communication. Talking Sticks are used by different groups in different ways, however they are often used during large cultural gatherings, when resolving disputes, or when conducting a ceremony or celebration where more than one person speaks. The Talking Stick is passed from person to person as they speak, and only the person holding the Talking Stick may speak at that time.

The Talking Stick teaches children the fundamentals of communication in a respectful, patient, and collaborative way. It encourages children to learn skills such as turn taking, self-discipline, and problem solving in a calm and safe environment.

1 Create the Environment

A Talking Stick is often used in a sharing circle, where everyone joins together to sit in a circle. Try using a talking stick when many different opinions should be shared, or if children are having a disagreement and need a tool to help them resolve conflict. You can also try it when there are just too many people talking at one time to ensure that everyone has a chance to say something.

Customs differ between communities, but there are some important common guidelines for using a Talking Stick.

1. Everyone will have a turn to speak. If an elder is present, they will always be first to speak.
2. Whoever is holding the Talking Stick decides when they are finished speaking. They can then give it to the person next to them, or to someone who has not spoken yet, but no one is required to speak if they choose not to.
3. When someone is sharing their thoughts, everyone else is expected to listen without interrupting or making comments.

Why

Through this experience, children learn to

- Communicate, use interpersonal skills, and diplomacy
- Foster positive coping strategies and problem-solving skills
- Communicate thoughts and experiences creatively using many different forms of expression
- Develop diverse language abilities and the capacity to communicate with others in many ways
- Experience the stories and symbols of their own and other cultures
- Express their own points of view and reflect on others' views

How

Children may need time to understand the concept of a Talking Stick and other related elements of respectful communication.

Share a story or a book about a Talking Stick, such as *The Talking Stick* by Dot Meharry. Sharing the story and having a discussion afterwards on the importance of a Talking Stick helps establish an understanding of the fundamentals of communication.

Where

This experience can be completed anywhere, but preferably in a space that is quiet and with few distractions. If completing the activity with a group of children, use an area where the group can sit in a circle.

When

This activity can occur at any time of the day but is best explored in small groups, or with the entire family.

References

Working Effectively with Indigenous Peoples Blog.

Retrieved from: <https://www.ictinc.ca/blog/first-nation-talking-stick-protocol>

Meharry, D. (2006). *The Talking Stick*. New Zealand: Raupo Publishing Ltd.

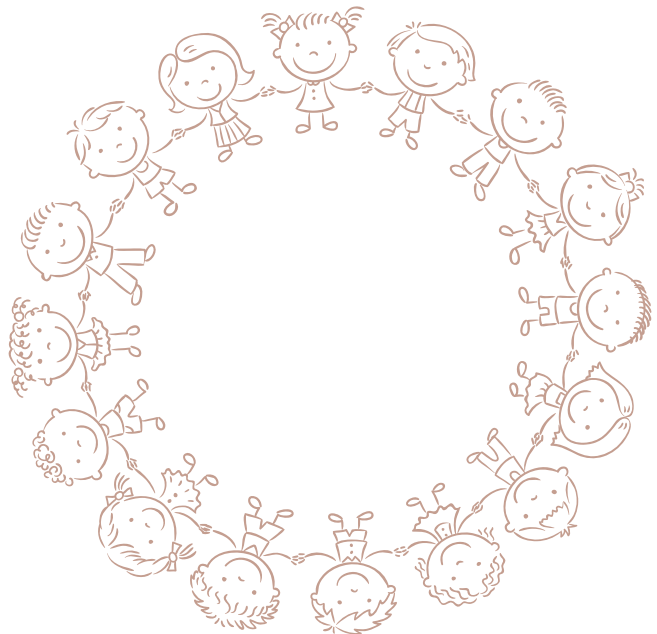

Triangles, Squares and Circles

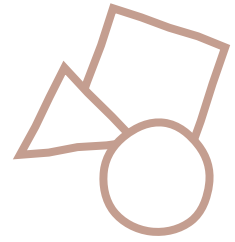

What

Shapes, patterns, and sequences can be particularly engaging for children who like predictability and routines. This activity can be played in a variety of ways to support their interests.

1 Create the Environment

- Cut out different shapes from a piece of paper such as large squares, triangles, circles, or rectangles. Your child can help you cut or draw shapes or give you ideas for what kinds of shapes they would like to play with.

2 Play with Shapes!

- Place the shapes in front of your child. Observe how your child interacts with the different shapes or creates patterns.
- If your child seems uninterested, try the activity another time when they're talking about shapes or patterns. You can also try adding stickers or faces to the shapes (e.g., a happy triangle or a sad square).

Why

Through this experience, children will learn to

- Build, create, and design using different materials and techniques
- Be curious about vocabulary, shape concepts, and spoken language
- Engage in sound and word play
- Use form, numbers, patterns and measurement in meaningful contexts

How

With your child, name the different shapes that you see. For example, point to a square, circle, or rectangle. Say the words together.

Try counting different numbers of shapes out loud together (e.g., count the number of squares, circles, or triangles).

Play a guessing game: "I have four sides and four corners. What's my name?" Try making up funny names for the shapes like "Silly Circle" or "Rascal Rectangle."

Encourage your child to make different patterns with the shapes. For example, make a square and triangle pattern together (square, triangle, square, triangle), and then ask your child what shape should come next and why. Remember that there isn't a wrong answer! Encourage your child to create their own pattern.

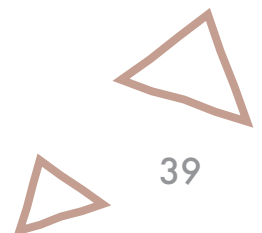

Encourage your child to create something with the shapes. For example, they could make an animal with the different shapes, a landscape, a person, or anything that they wish, using their imagination!

If your child likes to colour or design, encourage them to colour the different cut out shapes or create designs using different colouring materials.

If you play outside, the wind might blow away your pattern. This might be silly and fun, or it might be frustrating. You might also use natural materials for shapes instead (rocks, sticks, leaves).

Read a book with your child about shapes or other ideas that connect with this theme. Here are suggestions:

- *Circle, Square, Moose*, by Kelly L. Bingham
- *Shapes*, by DK Braille

Where

You can play anywhere, though a flat surface like the table, floor, or on the ground would work best.

When

This experience can occur at any time of the day.

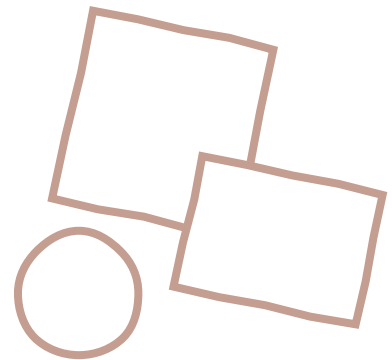

Let's Play!

Activities for Families



SET
3

Identities,
Social Responsibility,
and Diversity

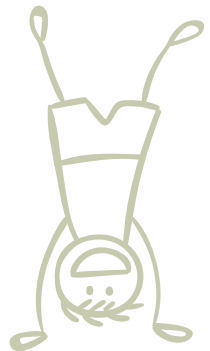

The Daily Dilemma



What

Many events that occur throughout a day may be joyful or happy, but daily events may also be frustrating, sad, or disappointing. This activity encourages children to talk about some of those times and find solutions to common problems. By talking about dilemmas outside of stressful situations, children begin to understand others' perspectives and learn to discuss and resolve challenges with others.

1 Create the Environment

- Introduce a dilemma that can easily occur in the home, community setting, or school. Share with your child that you are going to tell a story about a problem, and they can help the characters in the story solve the problem.

2 Daily Dilemma

- Together, make up or choose characters for the story. Be aware that the more characters in the story, the more complicated the dilemma may be.
- Tell a familiar story. For example, Timmy was working hard at making a very tall block tower. Bindy noticed the block tower and she thought it would be fun to knock it over. Just as Timmy placed his last block onto the tower, Bindy knocked the tower over.
- Ask your child, "How do you think Timmy felt? What are some things he might do after Bindy knocked the tower over? What are some things they could do together after the tower gets knocked down?"
- Do not solve the dilemma. Try to ask questions that help guide your child to a solution.

Why

Through this experience, children will

- Develop an understanding of differences in perspective
- Enhance language use and memory
- Foster identity by advocating for children's perspectives and feelings
- Practice problem solving for real-life challenges

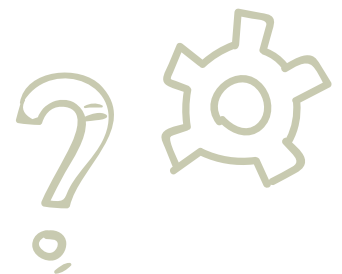

How

Encourage your child to think about the characters' feelings, particularly those whom they might not immediately understand.

Tell your child a Daily Dilemma story from your life. Ask for their ideas about how to solve it. Tell them what you did, or you may want to discuss other possible options.

Provide some options for solutions if children have difficulty coming up with their own. Providing a visual by drawing or taking pictures of your child using solutions supports memory, communication, and critical thinking. Some common solutions to challenging situations with peers might be to

- Ask a friend or a grown-up for help
- Take a deep breath
- Make a new choice
- Ask if you can help fix it
- Tell a friend how you feel or what you need
- Ask for or offer a hug

Use books, dolls, or puppets to demonstrate a situation and one of these solutions. Ask your child to tell a Daily Dilemma story about one of their own situations.

Read a book with your child about problem solving or other ideas that connect with this theme. Here are suggestions:

- *Accident!* by Andrea Tsurumi
- *I Love My Purse*, by Belle DeMont

Where

This activity can take place anywhere.

When

This activity can take place any time throughout the day. Some children might like or need the chance to practice a daily dilemma before going to child care or school, or after they get home.



Everything Changes



What

This is an experience that will help your child learn about difference and change.

1 Create the Environment

Talk to your child about changes that happen every day, such as the weather, a flower that has bloomed, the leaves that have fallen, or that their fingernails or toenails are longer than they were last week.

Talk about how some changes are big, and some changes are small. Sometimes, they may feel happy about changes, and sad about others, and that all feelings are okay.

2 Sharing Experiences

Ask your child to look around and find one thing that has stayed the same, and something else that has changed. Maybe the sunny sky of the morning is still sunny. Maybe a bird you saw outside has flown away. Ask your child, "What do you see?"

Why

Through this experience, children will learn to

- Express a positive regard and respect for self, others, and property
- Understand that all persons have value
- Understand, accept, and welcome changes and differences in themselves and the world around them

How

Explore with your child about some of the things that stay the same, and some things that are different or change. Point them out.

Explore with your child what these changes and differences might look like on paper, either through words, through drawings, or through another creative way.

Explore with your child how these changes and differences make them feel. You can discuss the changes, write them down, draw them, or express them through some other way such as acting them out.

Read a story with your child about weather, changes or other ideas that connect with the activity. Here is a suggestion:

- *The Apple Tree* by Sandy Tharp-Thee & Marlena Campell Hodson



Where

This activity can occur in any familiar area to your child.

When

This activity can occur at any time of the day.

Reference

Braun, M., & Stewart, W. (2017). *Mindful Kids: 50 Mindfulness Activities for Kindness, Focus and Calm*. [Activity Deck]. Cambridge, MA: Barefoot Books

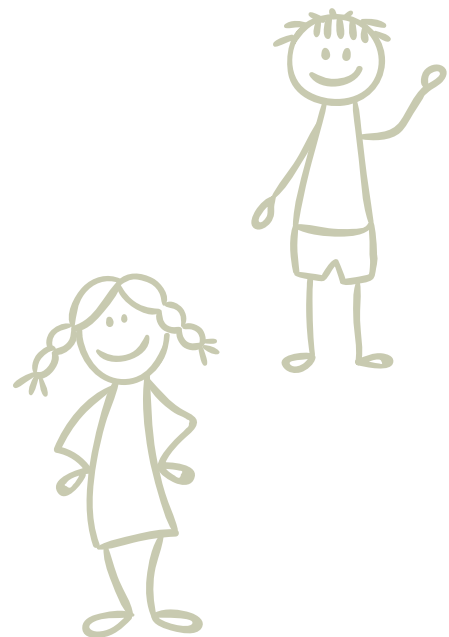

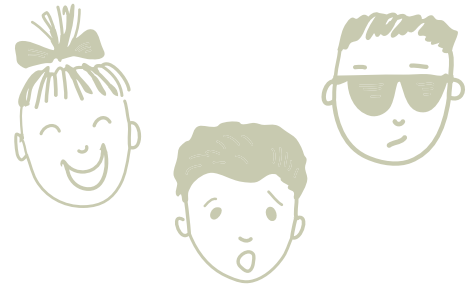

Face Collage

What

The Face Collage is a wonderful way to teach children about their personal identity, diversity, and foster a sense of belonging.

1 Create the Environment

- Take full-face pictures of your child, children, or your family members. Print the images on a full standard size paper (best in colour). Cut the picture into four to six vertical wide strips. To make the pieces more durable, you can laminate each strip or you can cover each one with clear laminate or packing tape.
- Mix the strips together into a basket and allow your child time to explore.
- Ask your child what emotions they see in the basket and share your observation. "I see a happy smile. That looks like your mouth!"

2 Collage

Children can piece the faces together or explore mixing the strips to create unique faces using facial features of themselves, their family, or friends.

Why

Through this experience, children will learn to

- Recognize, accept, and express a wide range of emotions, thoughts, and views
- Build healthy relationships with both adults and children
- Develop an understanding of diversity and inclusion
- Feel a sense of belonging and personal identity
- Develop emotional literacy skills
- Develop language and communication

How

You may start off with one or two faces with four vertical wide strips. Encourage language development by asking your child what they see. Try pointing at the facial features (for example, a nose, or eyes) and repeat the name several times to support word association. Also, if the child completes the face puzzle, you can repeat the person's name with your child. This helps children to strengthen their relationships with their peers and family members.



Add more faces with four to six vertical strips. Ask open-ended questions such as

- “What/Who do you see?”
- “Do they look the same to you?”
- “What do you think this is used for?” (When pointing to the facial feature, try talking about how humans and animals have similar features with similar functions but sometimes look very different)
- “How do you think they feel?”

Dialogue can sometimes be the most powerful way to support the growth and development of children. Building rich conversations based on the interests and inquiries of children can allow endless learning opportunities. Depending on where your discussion takes you, your child could learn about inclusion and embracing differences in others, emotional literacy, the human body, and basic mathematics.

Use images of unfamiliar people and make four to six vertical strips and four to six horizontal strips for each face. After building new faces, make up a story about who they are and what they enjoy.

Read a story with your child about feelings, families or other ideas that connect with the activity. Here is a suggestion:

- *My Nose, Your Nose* by Melanie Walsh

Where

This experience can be completed on a flat surface, indoors, or outdoors. You can also add magnets to the back of the strips and they can be placed on a magnetic board or on a fridge.

When

This activity can occur at any time of the day, and is best explored individually or in small groups.





Family Tree

What

At an early stage, children are eager to establish a sense of belonging in their world. A child's first words will often identify words or names for their siblings, parents, guardians, or care providers. As children become more confident in their abilities, and develop their individual personalities, they become increasingly aware of their similarities and differences with their peers.

This Family Tree exploration is a wonderful way to nurture a child's sense of belonging and identity as well as learn more about their family lineage and culture. It is also a simple way of exploring diversity between family units and ways of being.

1 Create the Environment

- The concept of "Family" has many ways of presenting itself. Introduce the idea by talking about your family, looking at family photos together, or reading a story about families.
- Talk with your child about different emotions that may arise within a family (e.g., a sibling might feel sad about a broken toy, an auntie might feel loved when getting a hug).

2 Explore your Family Tree

- Place images of family members/caregivers on paper or poster-board and begin making your family tree, starting with the child in the centre. Add images of grandparents, uncles, aunts, partners, cousins, or siblings. Do the same for caregivers.
- Try making your family tree resemble an actual tree by placing images on cut-out leaves or use real leaves to mount photos. Images might be connected by a line, string, or stick. This is a good way of visually showing the connection between family members and loved ones.

Why

Through this experience, children will

- Develop self-confidence, a sense of belonging, self-expression, and diversity
- Enhance communication, language, and literacy skills
- Develop creativity, critical thinking and problem-solving skills



How

You can play this activity with your child in various ways; however, it is best to “know your audience.” Adapt to your child’s individual needs, such as using personal photos, drawings, or by saying or writing names.

Try using the images in guessing games (i.e. guess the person/s name or other things about them).

Children who aren’t yet talking can match pictures to people who are close by. Rather than having your child repeat or say the names, ask your child, “Where is Daddy?” and have your child go to, look for, or point towards a person.

Try drawing images of family members instead of using pictures. You can also add individual family information under each image (where they were born, their favourite food, hobbies).

Children who are still learning the names of family members or caregivers can look at photos. Laminate the images (try using either laminate, packing tape, or plastic page protector sleeves) and place pictures on a key ring or in a box or stack. Names can be added on the front or back of photos. Talk about the images regularly to help your child become familiar with them.

If your child attends a classroom setting, consider inviting your child to share their family tree or photos with their friends. This may open great dialogue between peers.

Read a book with your child about different types of families.

Here are suggestions:

- *A Family Is a Family Is a Family*, by Sara O’Leary
- *The Family Book*, by Todd Parr

Where

This experience can be explored anywhere; however, it is ideally played at a table where you can assist in piecing together the family tree. It is best explored one on one or within a small group.

When

This activity can occur at any time of the day.

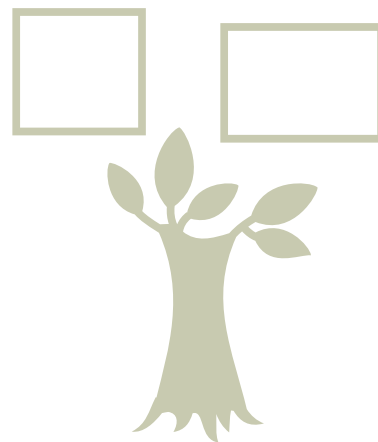

Gardening with Kids



What

Getting young children involved with gardening is a great way to connect with nature, learn about food, and how food grows. In the garden, children also get to use all of their senses (touch, taste, see, hear, and smell). For example, they can see fruits and vegetables as they grow, and possibly taste them once they are ripe. Children are often more keen to try something they have helped grow or prepare. Early spring is a great time to start seeds indoors and talk to children about our growing season.

1 Create the Environment

- Explore what a garden is with your child and the different things that can be found in a garden.
- Ask your child for their ideas about caring for plants and gardens.
- Look at pictures in books or gardens in your neighbourhood.
- Ask if they would be interested in making their own garden at home!

2 Gardening Activities

- Decide if you will be growing plants outside or only inside. If you do have room outside for a small garden or planter, encourage your child to help prepare the soil by weeding, tilling with shovels or sticks, and stirring in compost or other natural soil additions (avoid chemical fertilizers which can be toxic if ingested from children's hands).
- Choose your seeds with your child. Together, decide what types of vegetables or beans you could grow depending on the space and sunlight you have, and what your family and/or community has traditionally grown. For example, squash need to spread their vines along the ground and need more room like a large planter or garden plot. Tomatoes, herbs, lettuce, chard, and kale grow more vertically and can be planted in pots. Beans and peas need a trellis or a fence to grow up alongside. Save the seed packets to remind yourself of what your plants need to grow.
- Start growing your seeds inside by sprouting them in moist paper towels inside small plastic bags. Label the bag so your child can start to recognize words. Encourage each child choose (ideally) two types of seeds to start, just in case one doesn't grow. Place these in a sunny window. Check daily to ensure the towel stays moist and to watch for the seeds to open. Ask them what they see as the seeds sprout. Encourage them to draw what they see each day, and label it with one or two words.
- Once sprouted, together with your child, move to a small pot or an empty paper egg carton with some fresh potting soil (choose soil that is specifically for growing food plants). Egg cartons work well as they can be planted right into a bigger pot or the garden, and the paper will eventually break down (note that this won't happen with Styrofoam egg cartons).

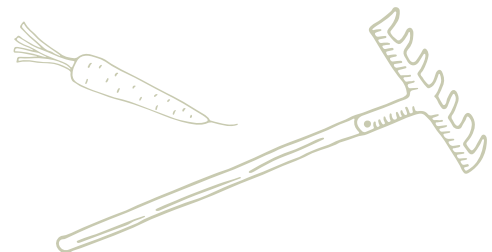

- Move seedlings outdoors (if you can) once there isn't a risk of frost outside. Some plants may need to stay warmer longer, like tomatoes. Some plants may need stakes to help support them.
- Encourage your child to try out the different gardener roles, like watering, weeding, and eventually picking the veggies. If you have more than one child, ask them to take turns trying out the different roles of the gardener. If your crop doesn't end up quite big enough for everyone to try some, consider getting some extra from the grocery store. Consider a taste test to see which tastes better!

Why

Through this experience, children will learn to

- Appreciate how their actions—through gardening—can affect nature and the planet
- Explore and learn about family, community, and the wider world by growing food that is important to their community
- Develop motor skills/abilities by planting the seeds and by pouring and scooping water or soil
- Appreciate and understand nutrition and nature
- Build empathy and see the impact of their actions in the environment around them

How

Some children might require guidance or assistance for the above activities. Do the activities with your child by guiding their movements with your own, such as hand over hand so that the child has the experience of doing the actions.

Create a space for your child to explore the different activities independently, and try watching from the sidelines. Observe their interests and ask questions that explore these interests further.

Encourage your child to think of new games and ideas that incorporate a gardening theme.

Read a story with your child about gardening or other ideas that connect with the activity.

Here is a suggestion:

- *A Day with Yayah* by Nicola Campbell & Julie Flett

Where

This activity can occur indoors or outdoors, depending on where the garden is being grown.

Check this listing of plants and when they grow during the year in British Columbia:

<https://www.appetitetoplay.com/healthy-eating/tips-ideas/seasonally-available-british-columbia-fruits-and-vegetables>

When

These activities can occur any time between morning and early evening.





People Playdough

What

Children learn about the world around them through inquiry and observation. They learn from those around them, and eventually, they discover or realize that there are similarities and differences between themselves and others. It is important during this process that parents, caregivers, and educators support development of a positive self-image as well as the understanding that diversity, or difference, is a fact of our world, and something to be celebrated.

1 Create the Environment

One way to introduce this activity is by reading a story about diversity such as *The Skin You Live In* by Michael Taylor. As you read the book together with your child, talk about the skin tone colours. After reading, look at your own arm and have your child guess what colour your skin tone is. If you are in a group, you can engage other children by asking what colour they identify as. Ask questions about their family members, about what they look like, and most importantly, what makes them unique or special.

2 Make Play Dough!

Cooked Play Dough Ingredients

- 2 Tbsp vegetable oil
- 4 Tbsp Cream of Tartar
- 2 cups all-purpose flour
- 1 cup salt
- Food colouring (see ratios)
- 2 cups water

Food Colouring Ratios for Different Skin Tones:

- Tan: 3 drops yellow, 2 drops red, 1 drop blue
- Brown [darker tan]: 3 drops yellow, 3 drops red, 3 drops blue
- Olive/Brown: 10 drops yellow, 8 drops red, 6 drops blue
- Pink/Blush: dip a toothpick into the red food colouring and swirl it into the water, adding tiny amounts until you reach the desired tone

Directions

Mix all dry ingredients in a bowl and set aside. In a saucepan, stir liquid ingredients over medium heat for 3-5 minutes, and add dry mixture slowly until the mixture congeals. Once cooled, you can knead the dough on a chopping board lightly dusted with flour. Note: Homemade playdough can be a little bit tricky. If it's not turning out quite right, try adding more flour or water as needed. Playdough is very forgiving, so keep working with it until you reach the proper consistency.

3 Play!

This child-led activity can be set up on a table with playdough or with a variety of materials such as body shaped cookie cutters, buttons, googly eyes, and a variety of yarn (orange, yellow, brown, black, and white). Your child can explore using the items to make a model of themselves, their peers, or any person they wish.



Why

This activity helps to

- Develop creative thinking skills
- Develop an understanding of diversity, individualism, and positive self-image
- Develop empathy and greater social and emotional awareness
- Strengthen fine motor (hand) skills
- Develop tolerance for a variety of sensory experiences

How

Try creating a model of yourselves, peers, or loved ones with the playdough and other items on the table. Reflect their exploration in positive terms. For example, if a child places strands of yarn on the belly of their person, you can say “You’re putting hair on your tummy,” instead of saying, “You don’t have hair on your tummy, you have hair on your head.” Observe what the child is doing and encourage explanation and discussion. Remember it’s about the process, not the product!

For children who are still learning to talk, create people together and help your child to label them as caregivers, educators, friends, or family. Show them photos if this helps your child to make connections.

To create another layer of sensory exploration, substitute food dye with natural ingredients such as carob, cocoa, ginger, mustard powder, paprika, cinnamon, chili and taco seasoning, to create colour density and a variety of skin tones in addition to different scents. This will encourage children to explore the diverse smell of different foods and engage in discussions about them.

Read a book with your child about diversity, making different types of dough or other ideas that connect with this theme. Here are suggestions:

- *Shades of People*, by Shelley Rotner
- *Suzie’s Sourdough Circus*, by Kathy Sager.

Check out MOSAIC BC, a BC charity serving immigrant, newcomer and refugee communities with programs and events across BC: <https://www.mosaicbc.org/about/>

Where

This activity is best suited for one to four children at a table where they can talk and explore.

When

This activity can be explored at any time of day. Make sure there’s plenty of time, so children aren’t rushing through the experience.

Reference

Hollander, D. (2012, Oct. 6). *Flesh Tone Play Dough Tutorial* [Blog Post]. Retrieved from https://littlestarslearning.blogspot.com/2012/10/flesh-tone-play-dough-tutorial.html?_sm_au_=iVVqMmmV7VpV5WBs

Restaurant Pretend Play



What

Children love to engage in pretend activities, including pretend play with food. This activity provides children with an opportunity to engage in dramatic play through pretending to plan, prepare, and serve food.

1 Create the Environment

Introduce the idea of a pretend restaurant. Together, decide on the foods that you will serve at your restaurant. You can choose foods that you both love, foods that are your child's favourites, or pretend foods.

2 Play Restaurant

Give your child some choices if they are having difficulty getting started. Here are some jobs that might need to be done to make a restaurant:

- Make a menu
- Set the table
- Prepare the food
- Get dressed (with an apron, hat, scarf, or whatever you imagine!)
- Wash dishes
- Invite guests

Why

Through this experience, children will

- Develop creative thinking skills
- Develop an understanding of diverse worldviews
- Strengthen literacy and communication skills
- Self-regulate while they are involved in role-play



How

Encourage your child to create the foods they've decided on; for example, use playdough, blocks, cut pictures from newspapers, magazines, or draw, colour or paint your own.

Together, make menus and signs for the restaurant. Your child can decide on a restaurant name, what kinds of foods you will serve, how much they will cost, and draw pictures of the foods.

Talk about what else might be needed to prepare for this restaurant (e.g., a place to sit, glasses, cutlery, napkins). Your child might even think of music they would like to play in the background while people eat!

If your child needs help to get started, show them how to do something (wash a dish, stir a pot) and encourage them to copy you. As they play, help them to string a sequence of things together: get a cup, pour something in, stir it, drink it!

Try asking your child open-ended questions such as "What things worked well?" or "What are some other things we might need?" Encourage your child to include these ideas and play again.

With your child, talk about who else they might want to invite to their restaurant. These could be people in the family, other favourite people, or even stuffed toys. Try making invitations and send them to these people to share food with your child at their restaurant.

Read a book with your child about pretend play in a restaurant or other ideas that connect with this theme. Here are suggestions:

- *Eat*, by Elizabeth Verdick
- *Soup Day*, by Melissa Iwai
- *There's a Fly Guy in My Soup*, by Todd Arnold

Where

This activity can take place indoors or outdoors where there is space to set up the restaurant.

When

This activity can occur any time throughout the day, month, or year.

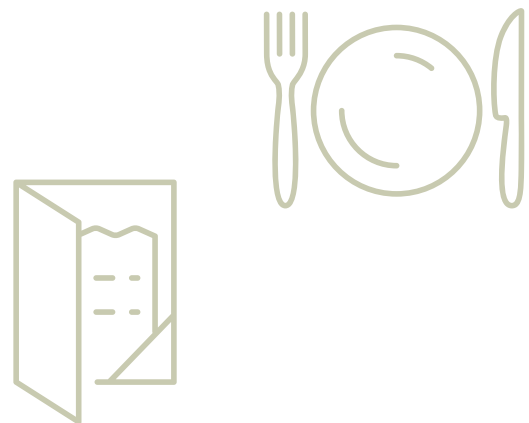

Telling Stories

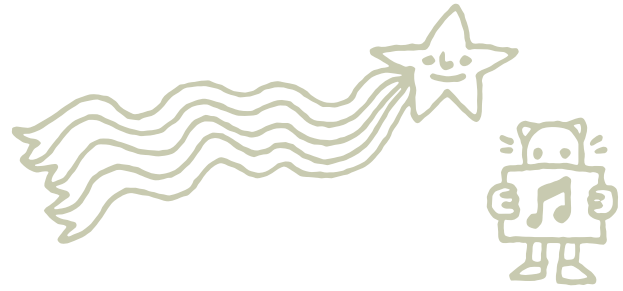

What

Try this activity if you are noticing that your child is interested in listening to stories, or is starting to develop stories on their own.

You don't need to be a master storyteller to delight your child with a story. You can tell a personal meaningful story from your own childhood. Children also love to hear stories about themselves, like the story of their birth and how much you were looking forward to meeting them.

It's okay for children to interrupt stories and ask questions. There's no right or wrong way, and this supports the development of self-esteem.

Just relax, have fun, and go with the flow!

Why

Through this experience, children learn to

- Appreciate your values and beliefs as well as your culture
- Explore and learn about family, community, and the wider world
- Appreciate and acknowledge new vocabulary and language comprehension
- Use critical thinking skills if you involve them in the story. For example, ask them what they think might happen
- Tell a story about themselves or their family
- See and hear a model of storytelling which will encourage them to make up their own stories
- Feel empowered by learning life lessons from their parent or caregiver

This activity can help you and your child to bond. Often, children like to snuggle while listening to the story. The physical contact makes them feel close and connected by spending the time talking and listening to each other.

How

If you don't have much experience telling stories, you can start with something short. For example, try telling your child about something funny that happened to you or something funny your child said when they were smaller.

Tell longer stories that you know well. Children love to find out more about their culture and family members through stories. You can tell them about things you used to enjoy as a child, or things that scared you and how you overcame your fear. Tell your child about people who were important to you and how they impacted your life. You can tell stories about your child and the things they used to love or fear and show how they've changed and grown.

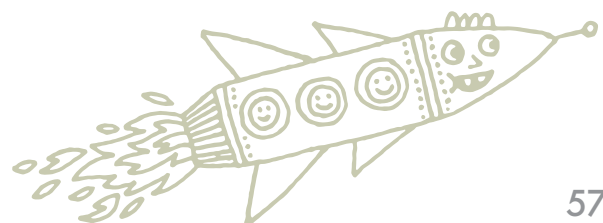

Involve your child in the telling of the story by asking questions like, “What do you think happened next?” or “How do you think that felt?” You can also make up stories where your child is the hero that saves the day. Include your child’s favourite character in the story. You can be creative or tell stories you know. Either way, children will love the attention and the time you spend talking together.

Explore stories at your local library:

<https://www2.gov.bc.ca/gov/content/sports-culture/arts-culture/public-libraries>

Read a book with your child about storytelling or other ideas that connect with this theme. Here are some suggested books you might find at your local library:

- *The Typewriter*, by Bill Thomson
- *I am a Story*, by Dan Yaccarino

Where

You can tell stories anywhere.

When

This activity can be done at bedtime, when you want to occupy your little one, waiting for an appointment, or while travelling. It can happen anytime when you or your child are in the mood!

Reference

Community Action Program for Children (CAPC)

<https://www.canada.ca/en/public-health/services/health-promotion/childhood-adolescence/programs-initiatives/community-action-program-children-capc.html>



Let's Play!

Activities for Families



**SET
4**

Well-Being and Belonging

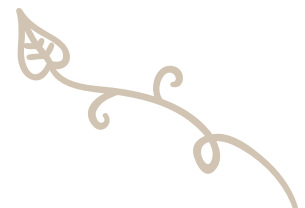

Being Calm



What

Try this experience with your child as a way to introduce positive coping strategies when dealing with challenging situations. It is based on the idea that when parents are calm, children learn to calm themselves, too.

1 Create the Environment

- Talk with your child about learning to be calm.
- Ask your child for times when they were upset or struggled to be calm.

2 Try sharing different ways of being calm with your child:

- Try doing calming activities together
 - » Take deep breaths together. “Breathe in while I count to three. Now breathe out while I count to three”
 - » Pretend to blow up a balloon
 - » Blow a cotton ball across a table
- Point out when your child is being calm
 - » “I see that you are breathing slowly. You look calm”
 - » “Holding your stuffed animal helps you calm down, doesn’t it?”
 - » “Your face looks relaxed—you are staying calm”
- Talk about being calm
 - » “Let’s take some deep breaths together before we go outside”
 - » “I feel so much better after I have taken a few big breaths”

Why

Through this experience, children learn to

- Feel a sense of security, self-respect, and self-regulation
- Express a sense of personal well-being
- Recognize, accept, and express a wide range of emotions, thoughts, and views
- Build healthy relationships with adults

*Breathe
Deeply*

How

Let your child watch you take deep breaths. Explain what you are doing as you breathe in and out.

Gently blow your breath out slowly onto your child's face, then smile. You can also try blowing out candles or blowing bubbles.

Hold your baby chest-to-chest and breathe slowly for a few minutes—your baby will feel calmer.

Place a toy on your child's stomach, and they can lift and lower the toy with each breath.

Incorporate mirrors so your child can see themselves in different emotional states (parents should try to stay as calm as possible).

Talk about being calm. For example, "Let's think together. What are some things that help us stay calm?" Try to use the suggestions you come up with together (i.e. taking a deep breath, pausing before speaking), then describe and positively reinforce what your child tried.

Here are some ideas, but brainstorm with your child other ideas that will be helpful:

- If you are feeling sad, sick, tired, bored, sluggish—try stretching
- If you are feeling happy, calm, feeling okay, focused—drink water
- If you are feeling frustrated, worried, or feel like you are losing control—take deep breaths
- If you are feeling mad/angry, scared, upset or out of control—take a break

Pause and think about being calm throughout the day...

- First thing in the morning
- At bedtime
- Before and during a new activity
- When you're frustrated or anxious
- When you are in a hurry

Read a story with your child about animals, movement or other ideas that connect with the activity.

Here is a suggestion:

- *Breath* by Scott Magoon

Where

This activity can occur anywhere, preferable in a quiet place away from noise and distractions.

When

This activity can occur during any time of the day.

Reference

The Child & Family Partnership www.reachinginreachingout.com

Relax

Building a Sandcastle or Snowcastle



What

This is a game you and your child can play in winter or in the summer, and it is especially fun with a group of children. Here are some ideas on how to do this:

1 Create the Environment

- Show pictures and discuss sandcastles or snowcastles with your child, and see if they would be interested in making one.
- Brainstorm ideas on what material you would need to make the castle, and see if you have it around the house. Regular sand buckets or plastic drinking glasses can create a magnificent castle of snow and ice, or of sand.
- Model language about teamwork, acknowledging that you are working together and that being a team makes you happy.

2 Building Activities

- When you go outside, designate one area or station for collecting the snow or sand in the buckets, and another area for building the castles to encourage movement from one space to another
- You can help your child fill up the bucket with snow or sand, and then help them turn the bucket over to the area where you are building the castle
- Run with your child from the place where you are collecting the snow or sand to the place where you are building the castle. Try hopping, galloping, skipping, or just walking to the castle from the collecting station.

While you are playing, consider asking your child questions such as

- How tall and big do you want to make the castle?
- How does the snow or sand feel?
- How can you decorate the castle together?

Why

Through this experience, children will learn to

- Build healthy relationships with both adults and other children
- Learn ways to keep themselves healthy, especially with physical activity
- Feel confident and in control of their bodies
- Enjoy being physically active



How

Help your child fill the bucket with snow/ice along with you. Invite children to help turn the container or bucket over and lift it away to make the castle.

Invite children to fill and turn the container over themselves. Encourage them to take turns or co-operate during each task.

Prompt your child to design their own style of castle, and encourage them to find other materials to be part of their creation (for example, rocks, sticks, shells).

Read a story with your child about building, snow or other ideas that connect with the activity.
Here is a suggestion:

- *Sandcastle Contest* by Robert Munsch & Michael Martchenko

Where

This activity can occur outdoors.

When

Try these activities in the morning or the afternoon.

Reference

Adapted from LIVE 5-2-1-0 and Appetite to Play:

<https://www.appetitetoplay.com/physical-activity/games-activities-3-5-yrs/snow-castle-relay>



Creating a Bundle of Fun with Watermelon

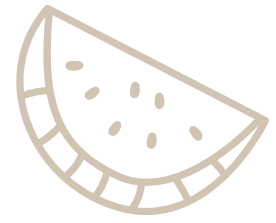

What

Children learn through all five senses (touch, smell, sight, hearing, and taste). In this activity, you will use a defined food theme, like watermelon (or any other food that your child likes or is interested in) and incorporate all five senses to help children learn about food. The more children understand about food, the more likely they are to try new foods and eat a healthy diet. Learning about food can be fun!

1 Create the Environment

- Notice what types of food your child is interested in. For example, they may enjoy watermelon, another type of fruit, or a traditional food or meal you have in your home or community.
- Tell your child what you notice and ask for more information. "I noticed that you love (watermelon)! What do you love about it?" Tell your child about a similar food that you love and why.
- If your child isn't yet answering complex questions, using visuals will help. Point to a picture or the actual food and label it. "Look! Watermelon!" Offer it for a snack.

2 Explore Food Together

- Have your child help you prepare the food or serve it for a snack. Observe how your child interacts with the food. For example, your child might try to grab the watermelon, bite into the watermelon, or try to pick out the seeds.
- Think of different ways your child can use their five senses to explore this food. You can ask your child questions such as "What does it sound like when you eat it?" or you can model using different senses "The watermelon feels cold/wet/sticky to me." Here are some words that describe watermelon that you could try:
 - » Taste: yummy, sweet, watery, crunchy, fresh, juicy
 - » Touch: sticky, cold, hard, squishy, wet
 - » Smell: fresh, bland, sweet, earthy
 - » Sight: drippy, bright, colourful, speckled, round
 - » Hear: crunchy, mushy, soft, loud

Why

Through this experience, children will

- Build a healthy relationship with food including beginning to develop skills to grow, select, and cook food
- Understand and enjoy the different qualities of food
- Learn ways to keep themselves healthy, including guidelines for good health
- Build healthy relationships with both adults and children (when playing)



How

Ask your child open-ended questions about the food they like:

- Where do you think this food comes from, or where is it grown?
- What colours do you see?
- What does it feel like?
- What do you think it tastes like?

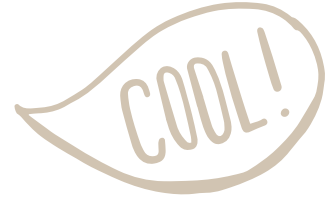

Gather a variety of foods, some preferred and some non-preferred, and have a taste test! Use toothpicks or forks if your child is hesitant to touch foods with their fingers. Model trying a new food by putting your lips and/or tongue to it, describing it, and then putting it down. Keep the activity open-ended and fun to avoid a power struggle over trying new foods.

Let children prepare the watermelon by cutting it with cookie cutters or plastic/butter knives. Be sure to support your child's safety if it's their first time using a knife.

Try out a silly rhyming song, like *Down by the Bay*, and sing together while you're eating or preparing the watermelon.

Try different colours of watermelon or freeze it using popsicle sticks as holders, for a new and different texture.

Using chalk, draw watermelons, vines, and leaves on a sidewalk or on a concrete playground. You can hop through the patch to try to land on the watermelons, hop over them, or you can make up your own game!

Read a book with your child about trying new foods.

Here are suggestions:

- *I Won't Eat That*, by Christopher Silas Neale
- *Sandwich Swap*, by Her Majesty Queen Rania Al Abdullah

SAFETY TIPS

- Help your child to wash their hands with soap and water before and after preparing food
- Supervise your child when using kitchen utensils, especially knives
- For active play, make sure the area is clear of obstacles before playing

Where

You can try this activity indoors or outdoors.

When

You can try this activity with your child before and during meal times or any time of the day.

References

Appetite to Play. Creating a bundle of Fun – Using Themes to Incorporate Food Literacy.

Retrieved from <https://www.appetitetoplay.com/healthy-eating/tips-ideas/creating-bundle-fun-using-themes-incorporate-food-literacy>

Appetite to Play. Bundles of Fun with Watermelon.

Retrieved from <https://www.appetitetoplay.com/healthy-eating/food-activities/bundles-fun-watermelon>



Hummm!

What

Humming and singing can be a way to work through difficult and challenging emotions that your child might have. Use this activity as a tool to support your child to relax and breathe through a variety of situations.

1 Create the Environment

- If your child is going through difficult or challenging emotions, try sitting with your child in a space that is calming to both of you. Sit up straight but remain relaxed.
- Explain that you have learned something new and you would like to try it together.

2 Make a humming sound. Hummmm!

- With your child, close your eyes and your lips. Hum a few notes to yourself until you find one that you like. Try asking your child to do the same.
- Breathe in deeply. Breathing out, hum your note. Breathe in. Breathe out and hummm!
- Ask your child to press their hands to their chest to notice the vibration of the humming. Ask your child what they feel in their hand and in their body.
- Breathe in. Breathe out and hummm! Ask your child to let the humming send peace or calm into their body and their heart.
- Before your child finishes the exercise, ask your child to quiet their humming and take three soft breaths.
- Ask your child how they feel. Try asking your child if they want to try a different note that might make them feel better and calmer.

Why

Through this experience, children will

- Recognize, accept, and express a wide range of emotions, thoughts, and views
- Adapt to experiences of change, surprise, and uncertainty
- Practice ways to keep themselves healthy, including regulating their emotions
- Feel a sense of security, self-respect, and self-regulation
- Build healthy relationships with both adults and others

How

Your child might need practice before doing this activity with you. If so, model breathing and humming for your child and encourage them to try something (e.g., close their eyes, sit up straight, breathe, or hum).

Instead of humming, try a favorite song that is slow and soothing. Or try slowing down a favorite song that is usually fast and exciting.

Show your child how you can use this tool when you feel difficult or challenging emotions. When you start to get frustrated or impatient, notice out loud (“I’m starting to feel frustrated”), and tell your child that you will try and hum. Be honest with your child about whether it helped you. Maybe they will have an idea for another tool!

Have your child sit on your lap, so they can feel both the vibrations of your humming and your deep breathing.

Read a book about relaxing and becoming calm or something else that connects with this theme.

Here are suggestions:

- *Breathe Like a Bear*, by Kira Willey
- *I Am Peace*, by Susan Verde

Where

Try to find a quiet, calming spot. Sometimes closing your eyes and sitting close together covered with a blanket or a jacket can create a cozy spot.

When

This activity can occur during any time of the day.

Reference

Braun, M., & Stewart W. (2017). *Mindful Kids: 50 Mindfulness Activities for Kindness, Focus and Calm*. [Activity Deck]. Cambridge, MA: Barefoot Books.

Pizza Pizzazz



What

Cooking with your child, or pretend cooking, is a good activity for developing imagination, learning about where food comes from, and engaging in mealtime conversation. Children are more likely to try a variety of fruits and vegetables if they have a chance to learn about them in a fun way. Homemade pizza can be a healthy meal because it includes all food groups.

1 Create the Environment

- Ask your child if they would like to make a (pretend) pizza with you.
- Share a memory of having pizza or ask your child to remember the last pizza they had. Was it a special occasion? Did someone take the last slice of their favorite kind? Was the pizza spicy?

2 Play!

- Play “pizza making” with your child using playdough, blocks, scarves, or other open-ended materials. Let your child lead the pretend play.
- Ask questions like, “Who will make the dough, and who will prepare the toppings?” and “How are we going to cook our pizza?”
- Talk about what kind of pizza you want to eat. “I like (name a food) on my pizza. What do you like on your pizza?” Talk about common pizza toppings and silly or make-believe pizza toppings.
- Pretend to eat pizza together. Sit down and enjoy a conversation while you eat.

Why

Through this experience, children learn to

- Explore the world using their bodies and their senses
- Build, create, and design using different materials and techniques
- Be creative and expressive in a variety of ways

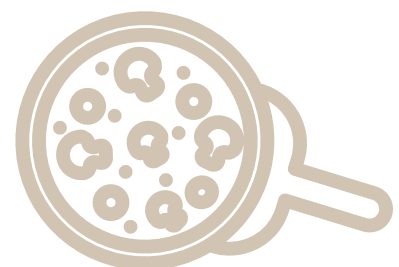

How

Start with pretend play, then you might try making real pizza.

Help your child lead the pretend play by asking questions that encourage imagination—“What should we use to make pizza sauce? What kind or colour of cheese should we use?”

For children who are learning to talk and play, try copying their play, and then introducing one new idea. If your child is focused on building a giant pizza, build a giant pizza alongside them. Then try “eating” a piece and say “Yum!!!” Watch to see if your child copies you.

Add some props like a rolling pin and cookie sheet. Make pizza menus with pictures of foods that go on pizzas.

Try real life pizza making and make individual pizzas using different breads as bases (English muffins, pitas, bagels, roti, bannock, or tortillas). Encourage your child to choose their own toppings.

For special days, make pizza treats, or try some of these ideas:

- Create “Cookie Cutter pizzas.” For Halloween, cut pita bread or English muffins with a jack-o-lantern cookie cutter. Add peppers, mushrooms, ham, or turkey cut into shapes for the eyes, nose, and mouth.
- Create “Holiday Pizzas.” Shape dough into a heart for Valentine’s Day or an evergreen tree for a winter celebration.
- Create “Fruit Pizzas.” Use biscuit dough as a base, yogurt for “sauce” and slices of apple, banana, pineapple chunks, and other fruits as toppings. Sprinkle with cinnamon.

Read a book with your child about pizza or other ideas that connect with this theme.

Suggestions are:

- *Pete’s a Pizza* by William Steig
- *Pizza at Sally’s* by Monica Wellington

SAFETY TIPS

- Help your child to wash their hands with soap and water before and after preparing food
- Supervise your child when using kitchen utensils, especially knives
- For active play, make sure the area is clear of obstacles before playing

Where

This activity can be played indoors or outdoors.

When

Try this activity before mealtimes or any time for pretend play.

Reference

Appetite to Play. *Pizza Pizzazz*.

Retrieved from <https://www.appetitetoplay.com/healthy-eating/food-activities/pizza-pizzazz>

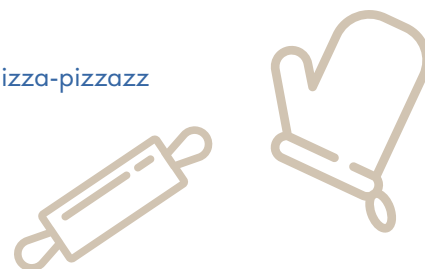

Sleeping Bunny



What

There are many simple, easy ways to explore movement with children. Rhythmic language and song make movement activities engaging and predictable. Try this poem and the accompanying actions with your child to explore more about body movement.

1 Create the Environment

- Ask your child how they're feeling. Be specific when telling your child how you're feeling (e.g. sleepy, playful, ill, calm).
- Tell your child that you learned a new game that you want to try together.

2 Sleeping Bunny

"See the little bunnies sleeping til it's nearly noon" (have your child pretend they are sleeping).

"Shall we wake them with a merry tune?"

"They're so still, are they ill?"

"No! Wake up bunnies!" (Encourage your child to stand up and do the following actions below).

"Hop little bunnies, hop, hop, hop" (encourage your child to hop around).

"Hop little bunnies, hop, hop, hop" (encourage your child to hop around and repeat as many times as you wish).

Why

Through this experience, children will learn to

- Find ways to keep themselves healthy including sleep and physical activity
- Feel confident in their control of their own bodies
- Enjoy being physically active

How

Try the Sleeping Bunny poem game.

Instead of hopping, try jumping or dancing, or whatever movement your child might want to try.

Explore what other animals your child wants to pretend to be. Before reading the poem, try asking your child questions such as

- What animal would you like to try next?
- How does that animal move?
- How can you make your body look like that animal?
- How can you make your body move like that animal?



Below are some examples of movements, but use your imagination to explore many ways to move.

Animal	Movement	Reminders
Horse	Gallop	Keep right foot always in front of the left as you step/run
Flamingo	Balance on one foot	Stand up tall, arms out to your side. Lift one foot and balance on the other
Tortoise	Move slowly	Move slowly and quietly
Frog	Squat down low and jump up high	Reach down and touch the ground between your feet, then jump
Bird	Move arms out to your side	Move arms up and down, as in flapping motions
Mouse	Move quietly, walk, step, or jump quietly	Run on your tippy toes as quietly as you can. Jump up and down while landing quietly, so no one can hear you!
Penguin	Step, waddle and kick, with small arm flapping (small movements)	Waddle, kick, waddle, kick!
Dinosaur	Step, stomp, run, or walk	Make big movements—could be light and fast or heavy and slow

These movements could be used for imitating many more animals. Try moving like superheroes, or try moving like nature’s elements such as the ocean, trees in the wind, a growing flower, pouring rain, or a tornado!

With your child, suggest making up a new creature. Discuss how children can act out their creature’s movements! There are many possibilities, but the key is to have fun and get kids moving!

Read a story with your child about animals, movement or other ideas that connect with the activity. Here is a suggestion:

- *The Way Home in the Night* by Akiko Miyakoshi

Where

This activity can occur indoors or outdoors.

Reference

Child Health BC. (2017). Appetite to Play. Retrieved from: <https://www.appetitetoplay.com/physical-activity/tips-ideas/teaching-fundamental-movement-skills>

When

This activity can occur any time of the year, or any time of the day.





Walking on the Wild Side

What

Exploring outside in the forest, on the beach, in the snow, or in other natural areas can be fun for children. This outdoor activity supports creativity and building confidence.

1 Create the Environment

- On a day you're ready to explore outside, give your child some time to get ready. If possible, give your child a choice about where to go.
- Look at the weather and talk together about what clothing you will need to wear to be comfortable.

2 Walk on the Wild Side!

- Go for a walk with your child or family and create different obstacles out of the natural things you come across. Here are some examples
 - » Jump in or over a puddle
 - » Hop over fallen twigs
 - » Roll down a hill or through a pile of leaves
 - » Balance along fallen trees
 - » Climb a tree or hang from a low hanging branch
 - » Find a rock to throw into a creek, lake, or ocean
 - » Collect a pile of leaves or pinecones. Try picking up one at a time, two at a time....
 - » Find a large rock to climb up and over
 - » Run to one tree, skip to the next, then walk sideways to another

Why

Through this experience, children will

- Feel confidence in, and control of their bodies
- Learn ways to keep themselves healthy, including different physical activities
- Explore the outdoors and learn about nature
- Adapt to and enjoy experiences of change, surprise, and uncertainty



How

Go for a walk with your child, and point out the different natural formations, elements, and growths that you see (e.g., trees, lakes, oceans, rocks).

Support your child if needed, by holding hands, helping them keep their balance, or putting them on your shoulders to feel branches and leaves of trees. Even children who are not yet walking love to climb and be held up high.

Encourage your child to try to balance, hang, or climb without help from an adult. If your child uses a wheelchair or a walker, try zooming fast through a puddle to make a big splash!

When you return home, talk about or write down all the movement or actions you created and see how many different locations you can perform these actions in, such as the beach, forest, mountains, and park.

Read a book with your child about exploring or other ideas that connect with this theme.

Here are suggestions:

- *Explorers of the Wild*, by Cale Atkinson
- *Sometimes I like to Curl up in a Ball*, by Vicki Churchill

Where

This activity has been created to occur outdoors.

When

Try this activity during daylight hours wherever it is bright enough to move around safely.

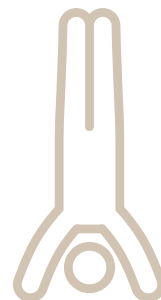

Yoga Poses



What

Move through a variety of yoga poses that are safe and fun for kids. Try asking questions to your child while doing the poses.

1 Create the Environment

Breathing

Every yoga class begins with a few quiet minutes to get the body and mind ready for the practice. Breathing helps our minds and bodies relax. You can say, "Let's sit in a comfortable position. Close your eyes. Slowly, breathe in through your nose (pause), and out through your mouth (pause). Breathe in through your nose (pause), and out through your mouth (pause). Feel your body and mind getting ready for yoga. Slowly open your eyes." You can ask, "How do you feel inside? How does your body feel? Are you feeling tired, or are you feeling awake?"



For younger children, you can also teach breathing by using a toy that is placed on your child's belly. Watch the toy rise as you inhale and drop when you exhale. You can also do this with an expandable toy sphere or balloon.

2 Poses

Child's pose

Tell your child, "Let's do the child's pose together." (Sit on your heels, lower your forehead to the ground and extend your arms way out in front of you). Ask, "Did you feel your knees pushing on your belly? This pose helps your belly digest food better." Push up on all fours, and return to sitting on your heels.



Downward facing dog pose

This pose helps build strong muscles, increases flexibility of the joints and spine, and builds confidence in our body's ability to move in unique ways. You can say, "Let's do the downward facing dog pose together." (Begin in an all fours position, hands under shoulders, and knees under hips. Curl your toes under. Straighten your legs and then straighten your arms. Hold this upside-down V position for three breaths. Carefully return to all fours). Ask, "How does your body feel? How do you feel inside? "Are you feeling tired, or are you feeling awake?"



Tree pose

Balancing poses, like the tree, improve our ability to focus, pay attention, and concentrate for longer and longer periods of time. Tell your child, "Imagine you are a tall tree with roots growing out the bottoms of your feet. Let's do the tree pose together." (Begin in a standing position with palms touching and thumbs resting on your heart. Shift your weight to your left leg and slowly raise your right foot to your ankle, shin, or inner thigh with your knee facing out. Slowly return your foot to the floor and repeat on the other side). Ask, "Was one side easier than the other? Balancing poses take practice, and you will get better and better!"



Sequences

There are sequences of yoga poses, done without stopping, which make our hearts beat faster, strengthening the heart muscle and giving us energy. Tell your child, "Let's put our downward facing dog and child's poses together." (Begin with the downward facing dog pose, lower to all fours and move into the child's pose, return to all fours and then the downward facing dog pose, back to all fours and the child's pose. Rest here). Ask, "Do you feel your heart beating faster? It's getting stronger!"



Why

Through this experience, children will be learning

- To communicate thoughts and experiences
- To be curious about vocabulary (for example, names of yoga poses) and concepts
- About their personal identity (deeper understanding of self) and mindfulness
- Problem solving
- Positive coping skills
- Personal emotions

How

Try the poses with your child.

Read a book about animals and act out the animals in yoga or other poses. Encourage your child to pose page-by-page along with the story.

Make up poses together: yoga for kids should be creative. Encourage your child to make up new poses and name them. This activity is great for practicing language skills. Make animal sounds. Use action gestures. Hop like a bunny and slither like a snake.

Read a story with your child about yoga, body awareness or other ideas that connect with the activity. Here is a suggestion:

- *A Morning with Grandpa* by Sylvia Liu & Christina Forshay

Explore HealthyFamiliesBC to find more activities to share with your child:

<https://www.healthyfamiliesbc.ca/home/about-us>

Where

This activity can occur indoors or outdoors.

Adapted from Appetite to Play and PBS Kids:

<https://www.appetitetoplay.com/physical-activity/games-activities-3-5-yrs/yoga-poses>

When

Try this activity any time of the day. You can even try it before sleep for relaxation.



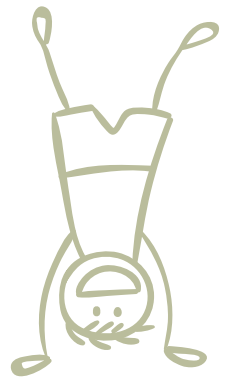
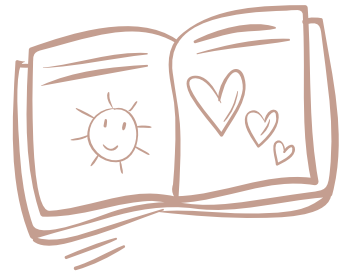
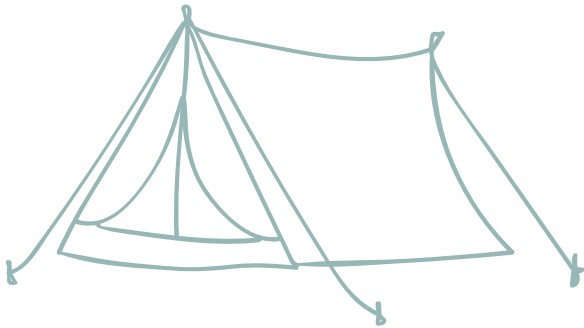
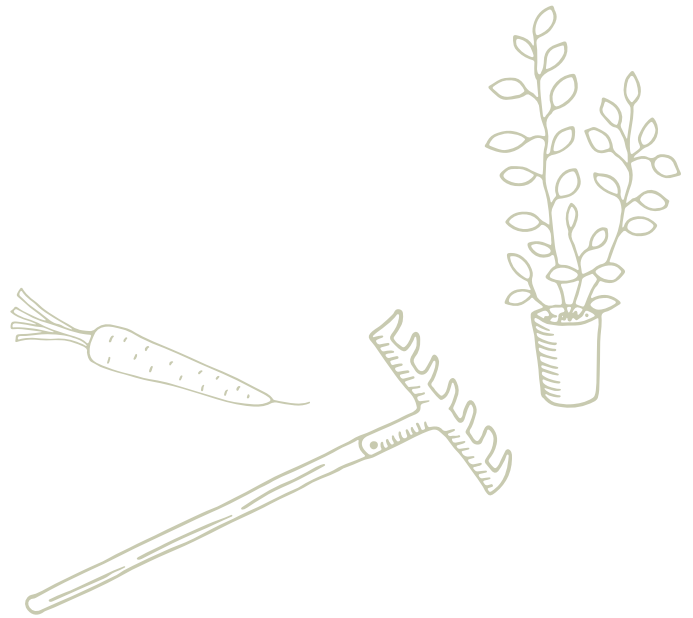

ISBN 978-0-7726-7328-2



Ministry of
Education