

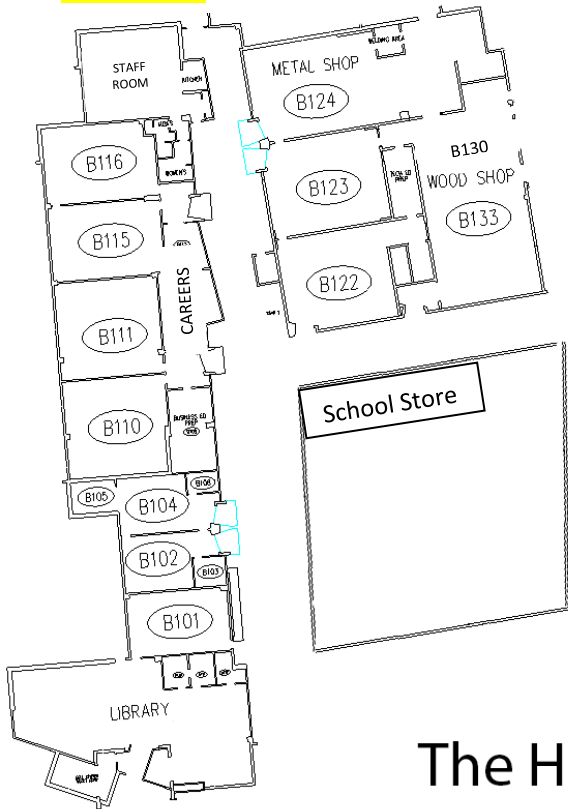

# SULLIVAN HEIGHTS SECONDARY



## Main Floor



## Second Floor

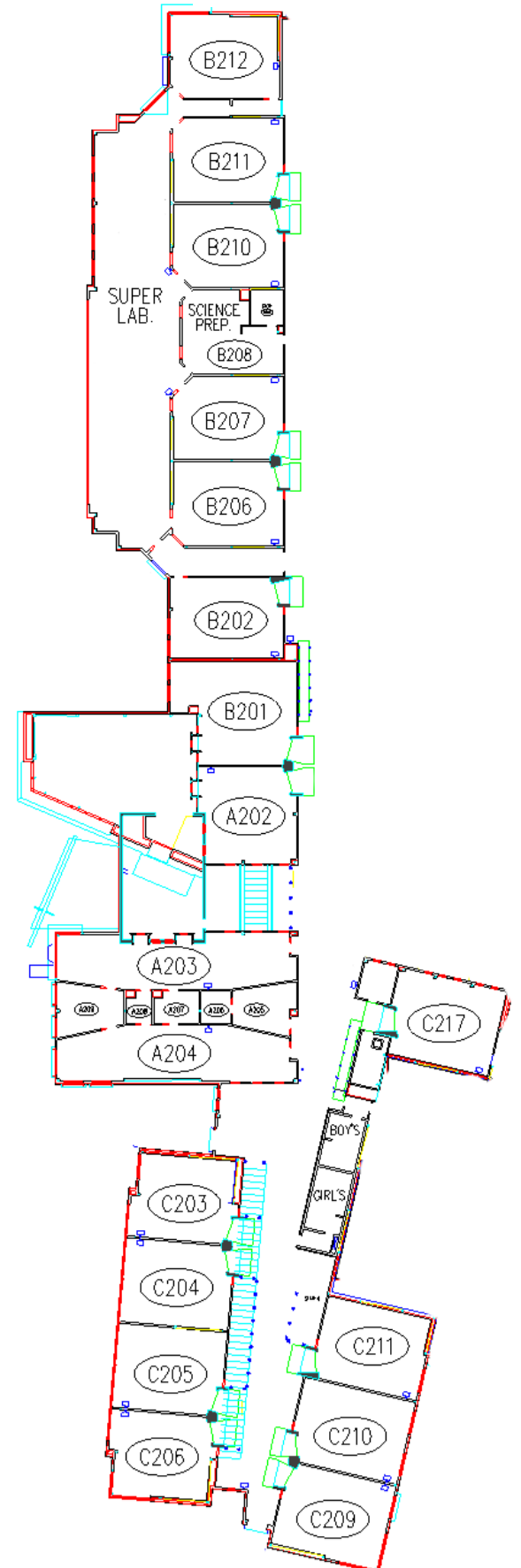

## The Hub

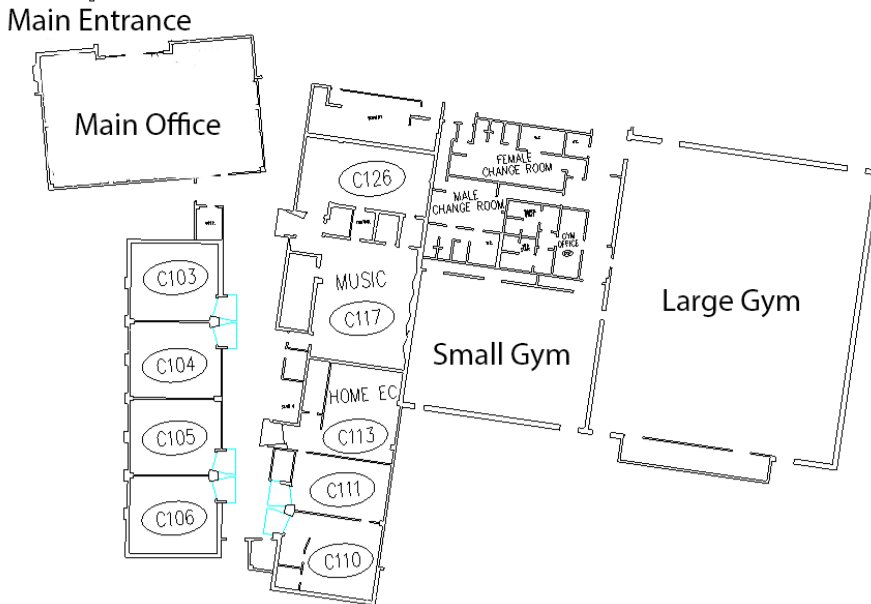

## Basement

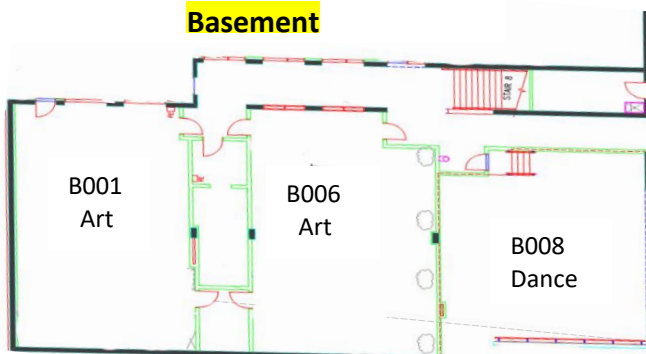

144 Street

Portables in front Parking Lot

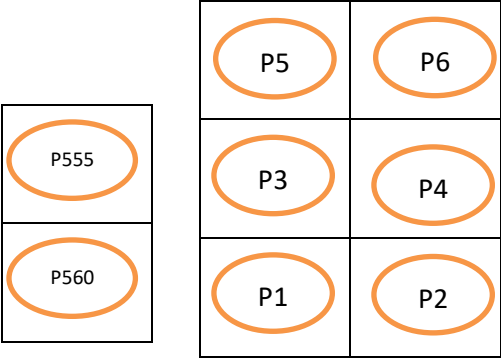

Portables in Back Parking Lot

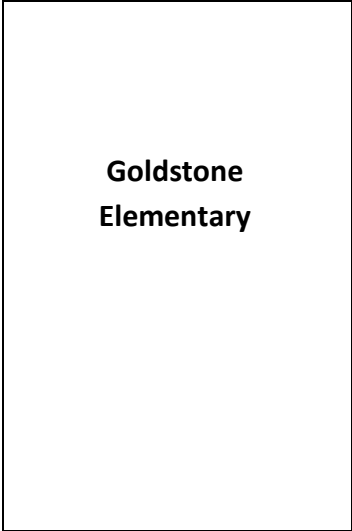
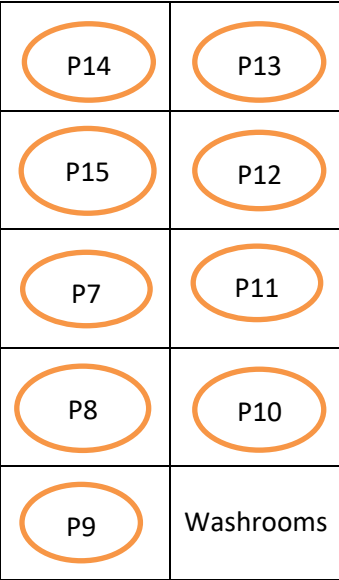

More Goldstone  
Portables

146 Street